



Electrical Specifications

Input		
Input Voltage (VAC)	120V-277V (+/- 10%)	
Frequency Range (Hz)	50 - 60 Hz (+/- 10%)	
	120V	277V
Input Current (A)	0.35	0.15
THD @ Full load	<20%	<20%
Power Factor @ Full load	>0.9	>0.9
Efficiency @ Full load	≥88%	≥88%
Inrush Current (Apk, T@10% of Apk) ²	5.6A, 130µs	14.6A, 110µs

² - Complies with NEMA 410 inrush current

General Information

Item Number	*2743WJ (57435)
	*2743WK (57436)
	*2743X9 (57459)
	*2743WS (57460)
	*2743XA (57461)
Type	Constant Current, Class 2
Output Power	35W (Max.)

Environmental Specifications

Ambient Operating Temperature	-20°C to 50°C
Case Temperature (Tc)	70°C (50kHrs) ¹
Max. Storage Temp.	70°C
Max. Relative Humidity (%)	85% non-condensing
Transient Protection	ANSI C62.41 Cat. A 2.5kV Ring Wave
EFT	IEC 61000-4-4 (1kV)
UL Rating	Dry & Damp
UL File number	E320395
EMI Compliance	FCC Part 15 Class A
Sound Rating	Class A

¹ - Warranty applicable only at 70°C

Output

Output Current (mA)	350mA/625mA/750mA
	525mA/625mA/675mA
Output Voltage (VDC)	20-50VDC
Output Ripple Current	<30% @ full load
Max. Output Power (W)	35W
LED Power-Up Time	<1sec
Load Regulation	<5% @ 750mA
Line Regulation	<5% @ 750mA
Over Voltage (4V over limit)	Yes, non-latching
Output Short-Circuit Protection	Yes, non-latching

Dimming

Dimming Control	0 - 10V
Dimming Range	10-100%
Dimming Type	Current Reduction
Dimming Input Isolation	2.5kV
Source Current	2mA max

CAUTION: Two power supplies if dimming is connected to non-class 2 circuits.



Ordering Guide

Item Number	Original Item Number	Ordering Description
*2743WJ	57435	OT 35W/UNV/0A7 CS L
*2743WK	57436	OT 35W/UNV/0A7 CS DIM L
*2743X9	57459	OT 35W/UNV/0A7 CS DIM L 525
*2743WS	57460	OT 35W/UNV/0A7 CS DIM L 625
*2743XA	57461	OT 35W/UNV/0A7 CS DIM L 675

Wiring Diagram

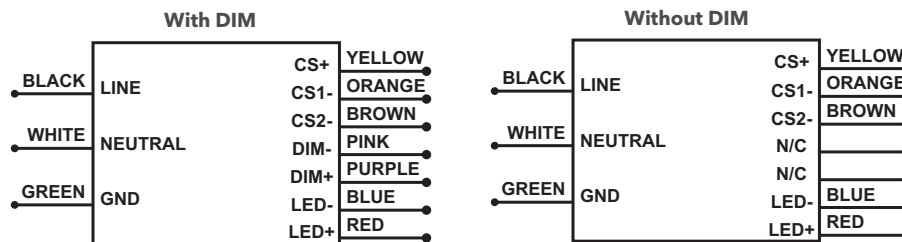

Note:

- Maximum suggested remote mounting distance is 8 feet.
- Use solid copper wire only (16-22 AWG).
- For Connections Use Wire Rated for at Least 90°C (194°F) or equivalent.
- Strip as below for all wires.

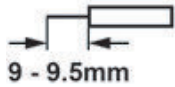

Selecting Currents

To select the desired output current value, short the output pins corresponding to the table below:

	No Short-Circuit	Short CS+ and CS1-	Short CS+ and CS2-
OT35 350mA/625mA/750mA	350mA	750mA	625mA
OT35 525mA/625mA/675mA	525mA	675mA	625mA

Note: The jumper wire should be completely insulated and conductive parts must not be accessible when installed on the driver's output connector.

Mechanical Diagram

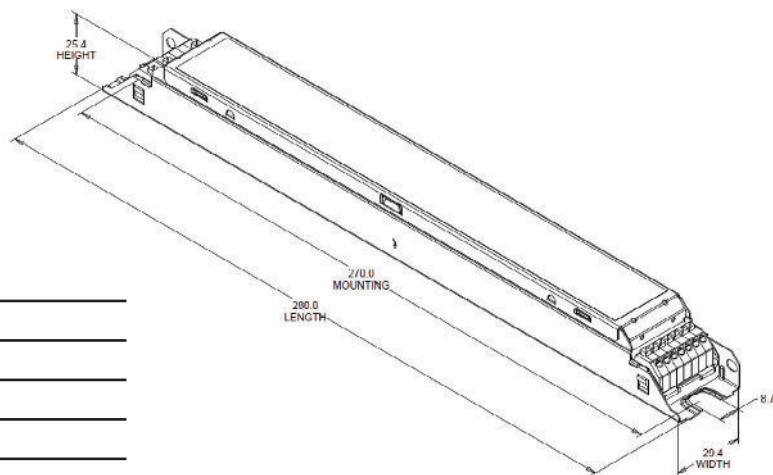

Mechanical Specification

Length	11.02" (280mm)
Width	1.15" (29.4mm)
Height	1.0" (25.4mm)
Mounting Length	10.63" (270mm)

Operating Range

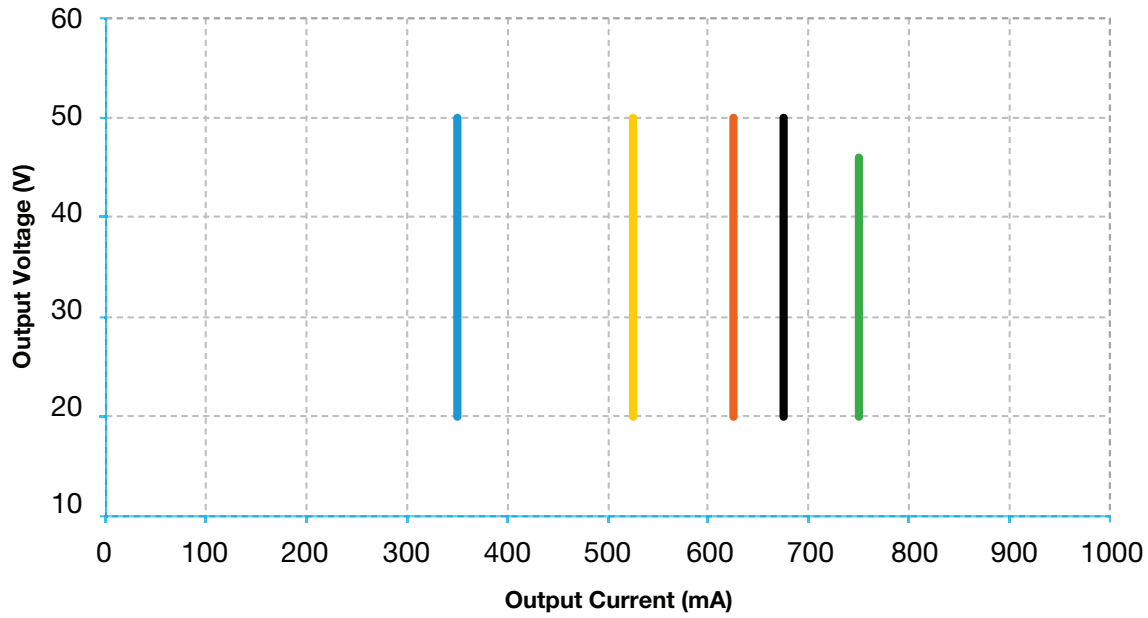

Note: Meeting DLC requirements requires minimum 50% loading.

Note: When using 750mA setting, load voltage cannot exceed 46V (35W max).

Dimming Curve

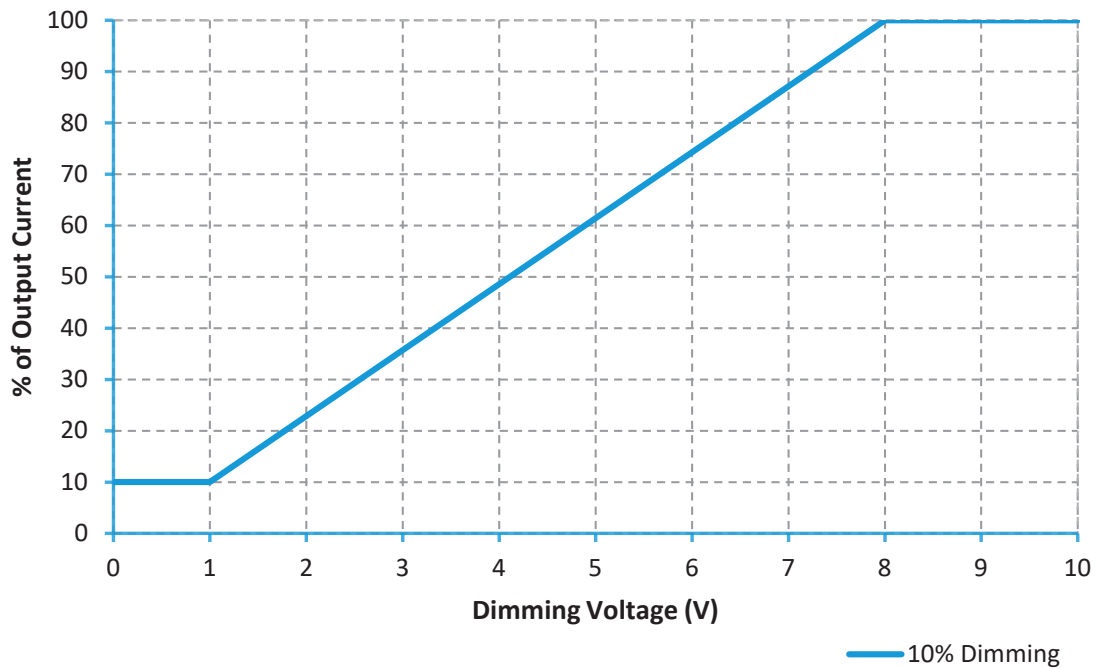

Efficiency vs. Output Voltage

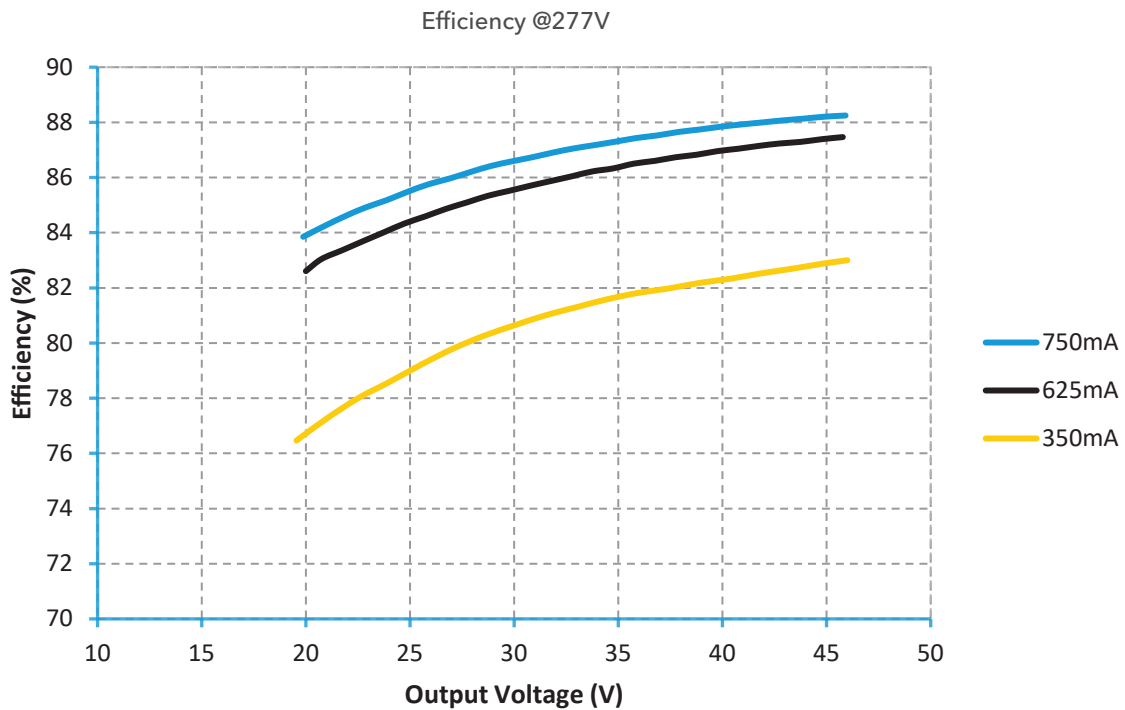
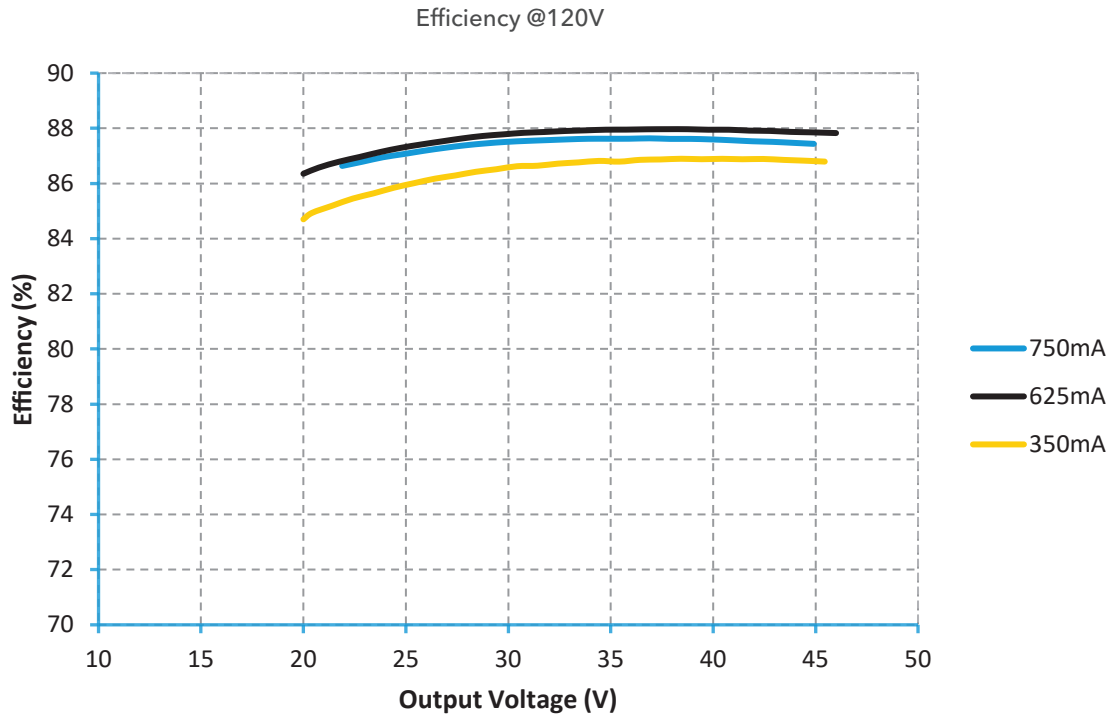

Power Factor vs Output Power

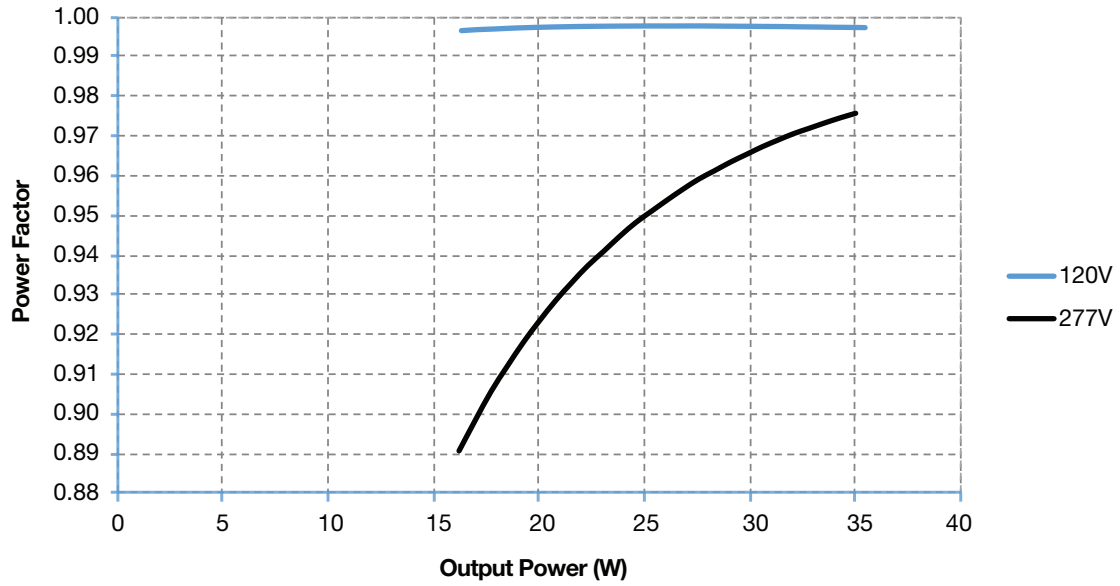

THD vs Output Power

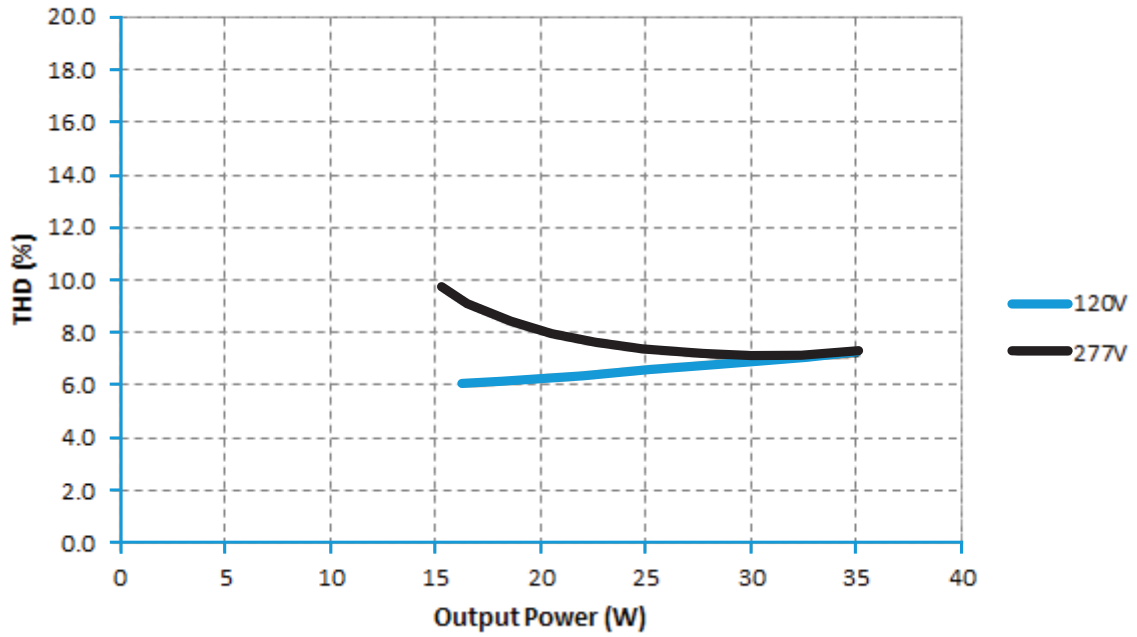

Warranty

eldoLED OPTOTRONIC® Products are covered by a 5-year limited warranty.
Complete warranty terms can be found at: www.eldoled.com/legal/terms-and-conditions

eldoLED

One Lithonia Way
Conyers, GA 30012
United States

+1 877 353 6533

nasupport@eldoLED.com
www.eldoLED.com

ECS-338R2 9-22

© 2022 Acuity Brands Lighting, Inc.
Specifications subject to change without notice. Actual performance may differ as a result of end-user environment and application.