



Driver LC 35W 150–1050mA 0-10V AUX Ip EXC UNV

Linear excite USB series

Product description

- Constant current LED driver
- Dimmable via 0 ... 10 V interface
- Dimming range 0 – 100 %
- UL8750 with class 2 output based on UL1310
- UL Listed Class P
- FCC Part 15, Class A
- Meets UL 8750 SF3.1 Isolation
- Adjustable output current between 150 and 1,050 mA via USB
- Max. output power 35 W
- Up to 90 % efficiency
- Meets strictest flicker free performance standards
- Nominal lifetime up to 50,000 h
- 5 years guarantee (up to $t_c = 75\text{ }^\circ\text{C}$)

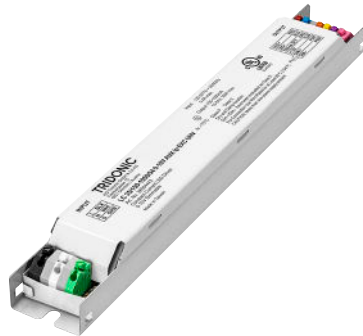

Housing properties

- Casing: metal, white
- Type of protection IP20
- Dry and damp location

Functions

- Adjustable output current in steps of 1 mA (USB)
- 12 V AUX output
- Dim to off dimming
- Protective features (overtemperature, short-circuit, overload, no-load, input voltage range)

Benefits

- Operating windows for maximum compatibility
- Added energy savings with dimming via 0 ... 10 V interface
- Configurable via USB programming
- Standard with linear dimming curve

Typical applications

- For linear/area lighting in office, education, healthcare, and general lighting applications

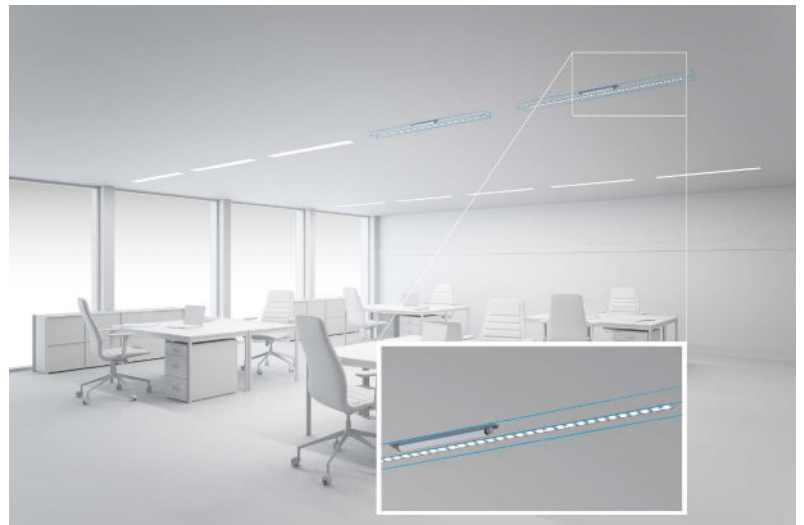

Standards, page 5

Driver LC 35W 150–1050mA 0-10V AUX Ip EXC UNV

Linear excite USB series

Technical data

Rated supply voltage	120 – 277 V
AC voltage range	108 – 305 V
Mains frequency	50 / 60 Hz
Typ. current (at 120 V, 60 Hz, full load) ^① ②	500 mA
Typ. current (at 277 V, 60 Hz, full load) ^① ②	200 mA
Leakage current (at 120 V, 60 Hz, full load) ^① ②	< 500 µA
Leakage current (at 277 V, 60 Hz, full load) ^① ②	< 500 µA
Max. input power (at 120 V, 60 Hz, full load)	46.6 W
Max. input power (at 277 V, 60 Hz, full load)	45.9 W
Typ. efficiency (at 120 V, 60 Hz, full load) ^③	83 %
Typ. efficiency (at 277 V, 60 Hz, full load) ^③	84 %
λ (at 120 V, 60 Hz, full load) ^④	0.98
λ (at 277 V, 60 Hz, full load) ^④	0.95
Typ. power consumption on stand-by (at 120 V, 60 Hz) ^⑤ < 1 W	
Typ. power consumption on stand-by (at 277 V, 60 Hz) ^⑤ < 1 W	
Typ. input current in no-load operation (at 120 V, 60 Hz) 20 mA	
Typ. input current in no-load operation (at 277 V, 60 Hz) 20 mA	
Typ. input power in no-load operation (at 120 V, 60 Hz) < 1 W	
Typ. input power in no-load operation (at 277 V, 60 Hz) < 1.5 W	
In-rush current (peak / duration at 120 V)	25 A / 100 µs
In-rush current (peak / duration at 277 V)	30 A / 100 µs
THD (at 120 V, 60 Hz, full load) ^⑥	< 20 %
THD (at 277 V, 60 Hz, full load) ^⑥	< 20 %
Starting time (at 120 V, full load) ^⑦	≤ 500 ms
Starting time (at 277 V, full load) ^⑦	≤ 500 ms
Turn off time (full load)	< 30 ms
Output current tolerance ^⑧ ⑨	± 5 %
Max. output current peak (non-repetitive)	≤ output current + 5 %
Output LF current ripple (< 120 Hz)	± 5 %
Output P _{STLM} (at full load)	≤ 1
Output SVM (at full load)	≤ 0.4
Max. output voltage	60 V
Dimming range	0 – 100 %
Mains surge capability (between L - N)	2.5 kV
Mains surge capability (between L/N - PE)	2.5 kV
Surge voltage at output side (against PE)	500 V
Type of protection	IP20
Lifetime	up to 100,000 h
Guarantee (conditions at www.tridonic.com)	5 years
Dimensions L x W x H	9.06 x 1.18 x 0.87 inch

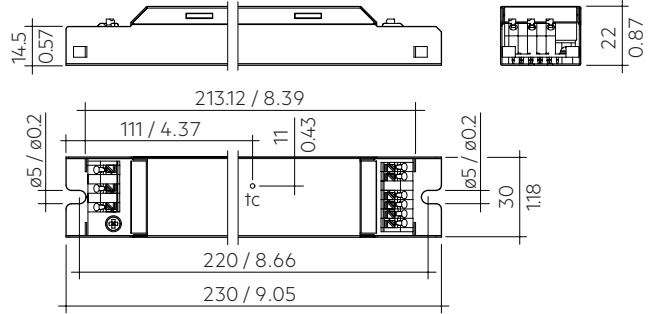

Dimensions in mm / inch

Ordering data

Type	Article number	Packaging carton	Packaging, low volume	Weight per pc.
LC 35/150-1050/54 0-10V AUX Ip EXC UNV	28004443	50 pc(s).	2,000 pc(s).	0.55 lbs

Specific technical data

Type	Output current ^④	Min. forward voltage	Max. forward voltage	Max. output power (at 120 V, 60 Hz, full load)	Typ. power consumption (at 120 V, 60 Hz, full load)	Typ. current consumption (at 120 V, 60 Hz, full load)	Typ. power consumption (at 277 V, 60 Hz, full load)	Typ. current consumption (at 277 V, 60 Hz, full load)	Ambient temperature ta max.
LC 35/150-1050/54 0-10V AUX Ip EXC UNV	150 mA	10 V	54 V	8.9 W	10.5 W	90 mA	10.9 W	52 mA	-20 ... +60 °C
	375 mA	10 V	54 V	22.3 W	25.1 W	211 mA	25.2 W	99 mA	-20 ... +60 °C
	600 mA	10 V	54 V	34.9 W	37.9 W	317 mA	37.6 W	142 mA	-20 ... +60 °C
	825 mA	10 V	42 V	36.7 W	38.7 W	324 mA	38.4 W	145 mA	-20 ... +60 °C
	1,050 mA	10 V	33 V	35.0 W	36.6 W	306 mA	36.3 W	137 mA	-20 ... +60 °C

^① Valid at 100 % dimming level.

^② Depending on the selected output current.

^③ No-load on AUX power supply.

^④ Output current is mean value.

^⑤ The table only lists a number of possible operating points but does not cover each single point. The output current can be set within the total value range in steps of 1 mA.

Product description

- Use programmer to set output current of LED driver
- USB or wireless version available
- Dimensions 104 x 45 x 28 mm / 4.09 x 1.77 x 1.10 inch



BTP Programmer UNV



USB Device Programmer Cradle



USB Device Programmer

Ordering data

Type	Article number
BTP Programmer UNV	28004447
USB Device Programmer Cradle	28004676
USB Device Programmer	28004677

1. Standards

UL 8750
FCC Part 15, Class A

Audible noise < 24 dBA.

Product not designed for European Economic Area.

This device complies with Part 15 of the FCC Rules. Operation is subject to the following two conditions:

- (1) this device may not cause harmful interference, and
- (2) this device must accept any interference received, including interference that may cause undesired operation.

2. Thermal details and lifetime

2.1 Expected lifetime

Expected lifetime 120 – 277 V

Type	Output current	ta	50 °C / 122 °F	55 °C / 131 °F	60 °C / 140 °F
	150 mA	tc	52 °C / 127 °F	58 °C / 136 °F	63 °C / 140 °F
		Lifetime	>100,000 h	>100,000 h	90,000 h
LC 35/150-1050/54 0-10V AUX Ip EXC UNV	>150 – 600 mA	tc	56 °C / 133 °F	61 °C / 142 °F	66 °C / 151 °F
		Lifetime	>100,000 h	100,000 h	70,000 h
	>600 – 1,050 mA	tc	61 °C / 142 °F	66 °C / 151 °F	70 °C / 158 °F
		Lifetime	100,000 h	70,000 h	50,000 h

Diagram for lifetime derating over tc:

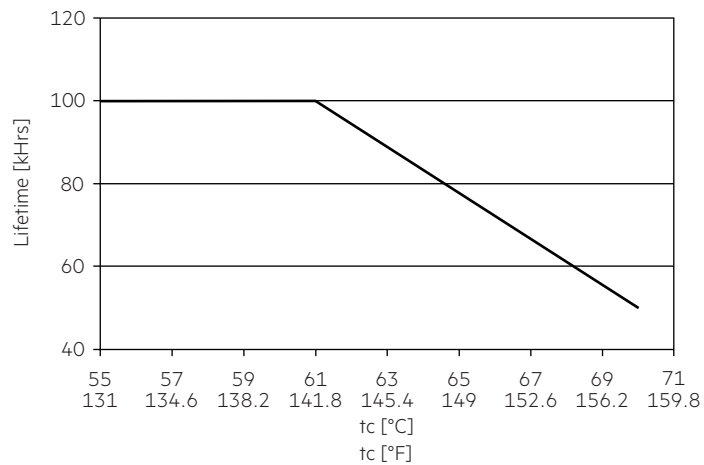

The LED driver is designed for a lifetime stated above under reference conditions and with a failure probability of less than 10 %. Lifetime chart is only a reference about the design, can not be used for warranty purpose.

3. Installation / wiring

3.1 Circuit diagram

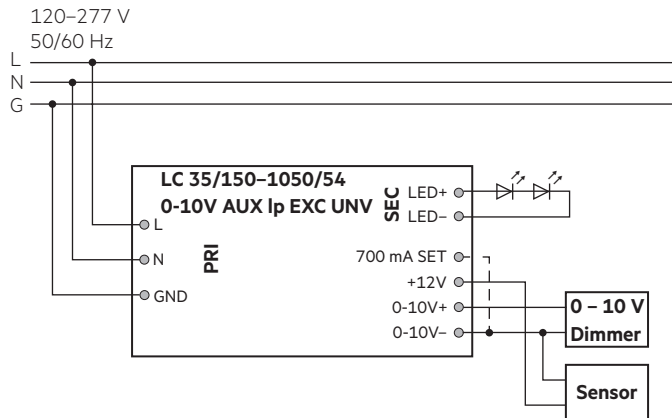

Primary terminal			Secondary terminal					
L	N	G	LED+	LED-	SET	+12V	DIM+	DIM-
black	white	green	red	blue	orange	yellow	purple	pink

PRI:

0.5 – 1.0 mm² (20 AWG – 18AWG), strip 8.5–9.5 mm (3/8 inch)

SEC:

0.2 – 0.75 mm² (24 AWG – 19AWG), strip 8.5–9.5 mm (3/8 inch)

3.2 Wiring type and cross section

For wiring use stranded wire with ferrules or solid wire from 0.2 – 1.5 mm² (AWG24 – 16).

Strip 8.5–9.5 mm (3/8 inch) of insulation from the cables to ensure perfect operation of the push-wire terminals.

Use one wire for each terminal connector only.

LED module/LED driver/supply

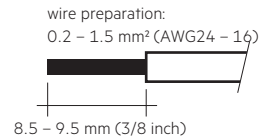

3.3 Loose wiring

Press down the “push button” and remove the cable from front.

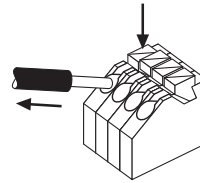

3.4 Wiring guidelines

- Run the secondary lines separately from the mains connections and lines to achieve good EMC performance.
- The max. secondary cable length (AUX, LED) is 2 m / 6.56 feet (4 m / 13.12 feet circuit).
- For good EMC performance, keep the LED wiring as short as possible.
- Secondary switching is not permitted.
- The LED driver has no inverse-polarity protection on the secondary side. Wrong polarity can damage LED modules with no inverse-polarity protection.
- Wrong wiring of the LED driver can lead to malfunction or irreparable damage.
- To avoid the damage of the driver, protect the wiring against short circuits to earth (sharp edged metal parts, metal cable clips, louver, etc.).

3.5 Hot plug-in

Hot plug-in is not supported for the LED output.

This can damage the LED load.

When connecting an LED load, restart the device to activate the LED output.

This can be done via mains reset.

When used in conjunction with a self-contained emergency LED driver the emergency device must break the mains supply to the driver during the test mode/emergency mode (delayed mains supply of the LED driver at mains return) to prevent hot plug-in of the LED load.

3.6 Earth connection

The earth connection is conducted as protection earth (GND).

There is earth connection required for safety reasons.

4. Electrical values

4.1 Operating window

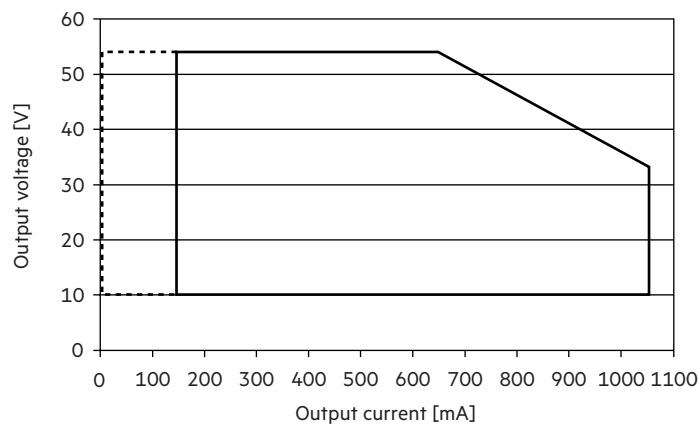

— Operating window 100 %

..... Operating window dimmed

Make sure that the LED driver is operated within the given window under all operating conditions. Pay special attention at dimming as the forward voltage of the connected LED modules varies with the dimming level, due to the implemented amplitude dimming technology. Coming below the specified minimum output voltage of the LED driver may cause the device to shut-down.

4.2 Efficiency vs load

120 V, 60 Hz:

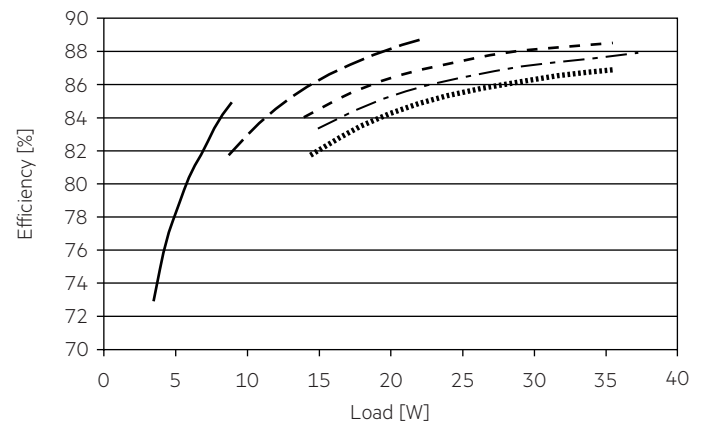

277 V, 60 Hz:

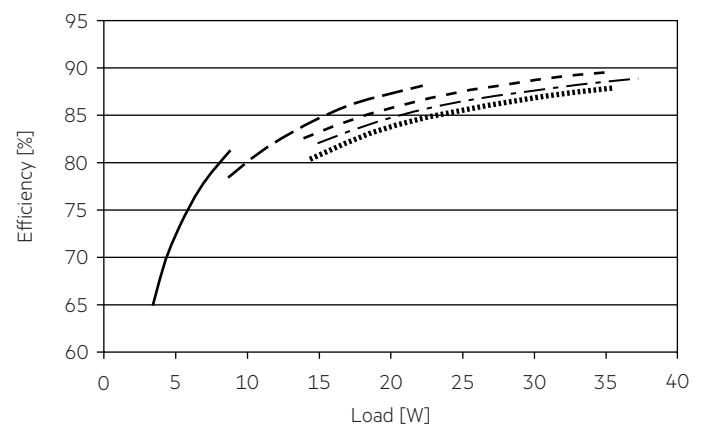

— 150 mA

- - - 375 mA

- · - · 600 mA

..... 825 mA

..... 1050 mA

No-load on AUX power supply.

4.3 Power factor vs load

120 V, 60 Hz:

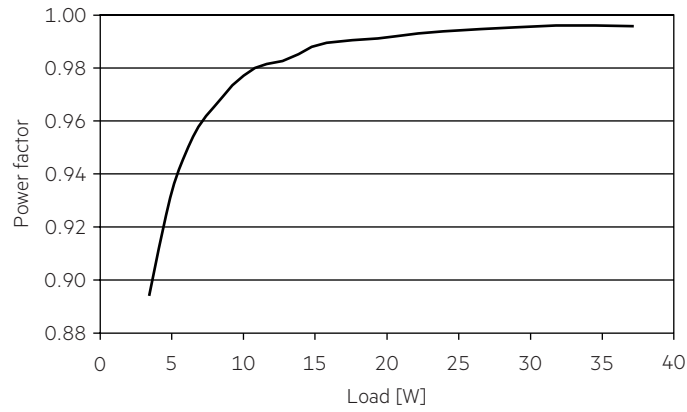

4.4 THD vs load

120 V, 60 Hz:

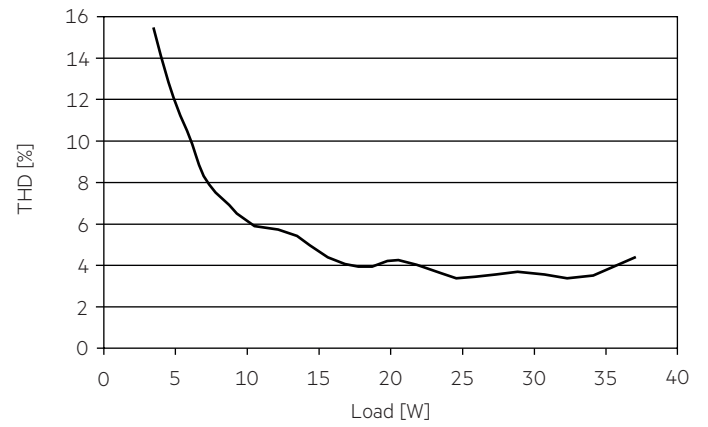

277 V, 60 Hz:

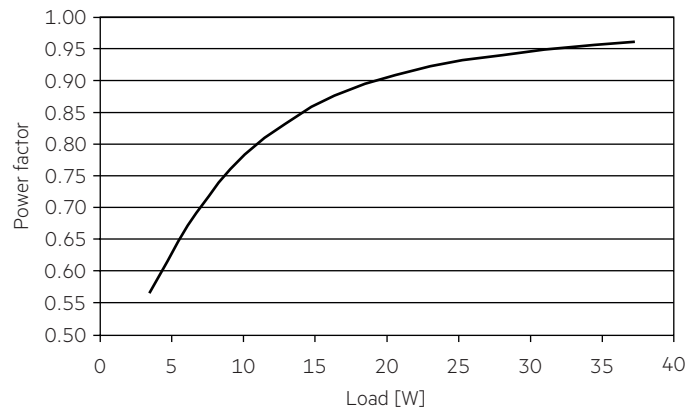

277 V, 60 Hz:

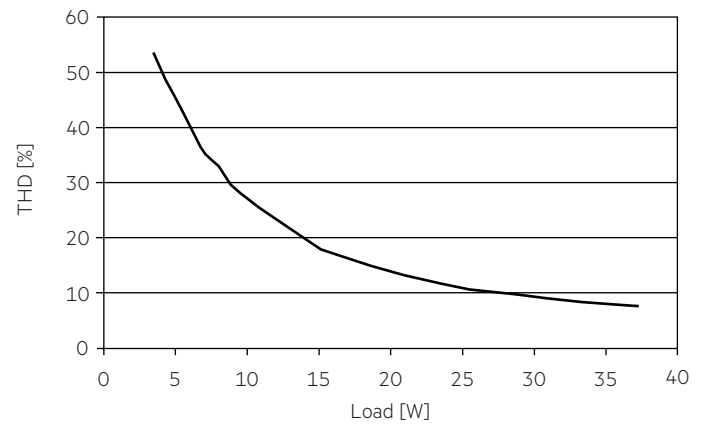

4.5 Maximum loading of automatic circuit breakers in relation to inrush current

120 V, 60 Hz:

Automatic circuit breaker type	C10	C13	C16	C20	B10	B13	B16	B20	Inrush current	
Installation Ø	1.5 mm ² / AWG16	1.5 mm ² / AWG16	2.5 mm ² / AWG14	2.5 mm ² / AWG14	1.5 mm ² / AWG16	1.5 mm ² / AWG16	2.5 mm ² / AWG14	2.5 mm ² / AWG14	I_{max}	time
LC 35/150-1050/54 0-10V AUX Ip EXC UNV	121	157	193	242	121	157	193	242	25 A	100 µs

277 V, 60 Hz:

Automatic circuit breaker type	C10	C13	C16	C20	B10	B13	B16	B20	Inrush current	
Installation Ø	1.5 mm ² / AWG16	1.5 mm ² / AWG16	2.5 mm ² / AWG14	2.5 mm ² / AWG14	1.5 mm ² / AWG16	1.5 mm ² / AWG16	2.5 mm ² / AWG14	2.5 mm ² / AWG14	I_{max}	time
LC 35/150-1050/54 0-10V AUX Ip EXC UNV	101	132	162	203	79	103	127	159	30 A	100 µs

These are max. values calculated out of continuous current running the device on full load.

There is no limitation due to inrush current.

If load is smaller than full load for calculation only continuous current has to be considered.

4.6 Harmonic distortion in mains supply in %

120 V, 60 Hz:

Type	THD	3	5	7	9	11
LC 35/150-1050/54 0-10V AUX Ip EXC UNV	< 20	< 2	< 1	< 1	< 1	< 1

277 V, 60 Hz:

Type	THD	3	5	7	9	11
LC 35/150-1050/54 0-10V AUX Ip EXC UNV	< 20	< 4	< 3	< 3	< 2	< 2

4.7 Dimming

Dimming range is 0 to 100%.

The operating window shows the minimum reachable power in dimmed state.

Recommended dimmers:

- Lutron DVSTV
- Lutron DDTV
- Leviton IP710

4.8 Dimming characteristics

Control input (0 – 10 V)

Control input open	max. dimming level
Interface current range	10 – 1200 μ A \pm 3 %
Max. permitted input voltage	0 – 11 V
Voltage range dimming	0 – 10 V ^①
Input voltage = 0 – 0.4 V	stand-by
Input voltage < 1 V	min. dimming level ^②
Input voltage > 10 V	max. dimming level ^③

Interface supports current sink dimmers.

Interface is class 2.

Supports hot plug-in.

^① See graph below (at full load):

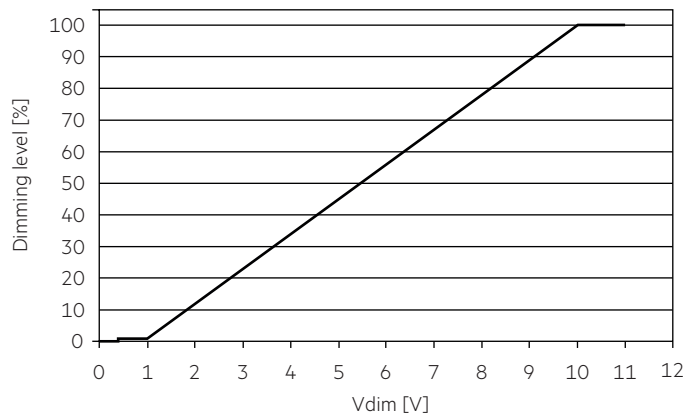

Part of the Dim to OFF detail:

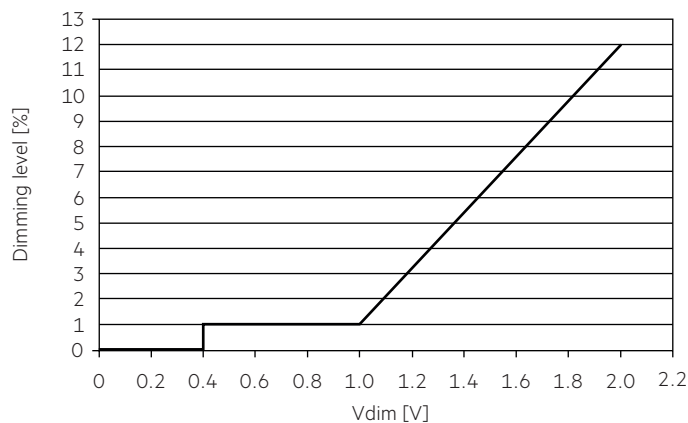

4.9 Insulation between terminals

Insulation	Mains	AUX	-LED / +LED	0-10V
Mains	-	double	double	double
AUX	double	-	basic	-
-LED / +LED	double	basic	-	basic
0-10V	double	-	basic	-

basic ... represents basic insulation.

double ... represents double or reinforced insulation.

5. Software / Programming / Interfaces

5.1 Software / programming

Configure the output current of the LED driver with appropriate software and interfaces:

Software for configuration:

- Current generator for desktop and Android

Interfaces for data transfer:

- Desktop app via USB
- Wireless via Android software

6. Functions

6.1 LED current

Set the LED current either via appropriate software or via jumper on the marked „700mA SET“ output terminal.

Factory default value is the min. LED current.

6.2 Integrated auxiliary power supply (AUX)

Auxiliary power supply to connect external sensor.

For wiring see circuit diagram.

Output voltage: 11 – 13 V

Output current: 100 mA max.

AUX port is active in stand-by mode.

Supports hot plug-in.

7. Protective features

7.1 Short-circuit behaviour

In case of a short-circuit at the LED output the LED output is switched off. After removal of the short-circuit the LED driver output will be activated again.

7.2 No-load operation

The LED driver will not be damaged in no-load operation. The output will be deactivated and is therefore free of voltage. If a LED load is connected restart the device before the output will be activated again.

7.3 Overload protection

If the maximum load is exceeded by a defined internal limit, the LED driver switches into hic-cup mode. After elimination of the overload the nominal operation is restored automatically.

7.4 Overtemperature protection

The LED driver is protected against temporary thermal overheating. Thermal overload protection is triggered if the ambient temperature reaches approximately 65 °C / 149 °F and the rated output current is reduced to 50 %. The device has to be restarted before the output returns to normal operation.

8. Miscellaneous

8.1 Insulation and electric strength testing of luminaires

Electronic devices can be damaged by high voltage. This has to be considered during the routine testing of the luminaires in production.

According to UL 8750 (informative only!) each luminaire should be submitted to an insulation test with 500 V_{DC}. The dielectric withstand test equipment shall employ a transformer of 500-VA or larger capacity and have a variable output voltage that is essentially sinusoidal or continuous direct current. The applied potential is to be increased from zero at a substantially uniform rate until the required test level is reached, and is to be held at that level for 1 minute.

As an alternative, UL8750 (informative only!) describes a test of the electrical strength with 2V AC + 1000V (or 1.414 x V DC). To avoid damage to the electronic devices this test must not be conducted.

8.2 Conditions of use and storage

Humidity: 5 % up to max. 85 %,
not condensed
(max. 56 days/year at 85 %)

Storage temperature: -40 °C / -40 °F up to max. +85 °C / +185 °F

The devices have to be acclimatised to the specified temperature range (ta) before they can be operated.

The LED driver is declared as inbuilt LED controlgear, meaning it is intended to be used within a luminaire enclosure.

If the product is used outside a luminaire, the installation must provide suitable protection for people and environment (e.g. in illuminated ceilings).

8.3 Maximum number of switching cycles

All LED driver are tested with 50,000 switching cycles.
The actually achieved number of switching cycles is significantly higher.

8.4 Additional information

Additional technical information at www.tridonic.com → Technical data

Lifetime declarations are informative and represent no warranty claim.
No warranty if device was opened.