

CLUB-E

1024

Ethernet to DMX Stand-Alone interface

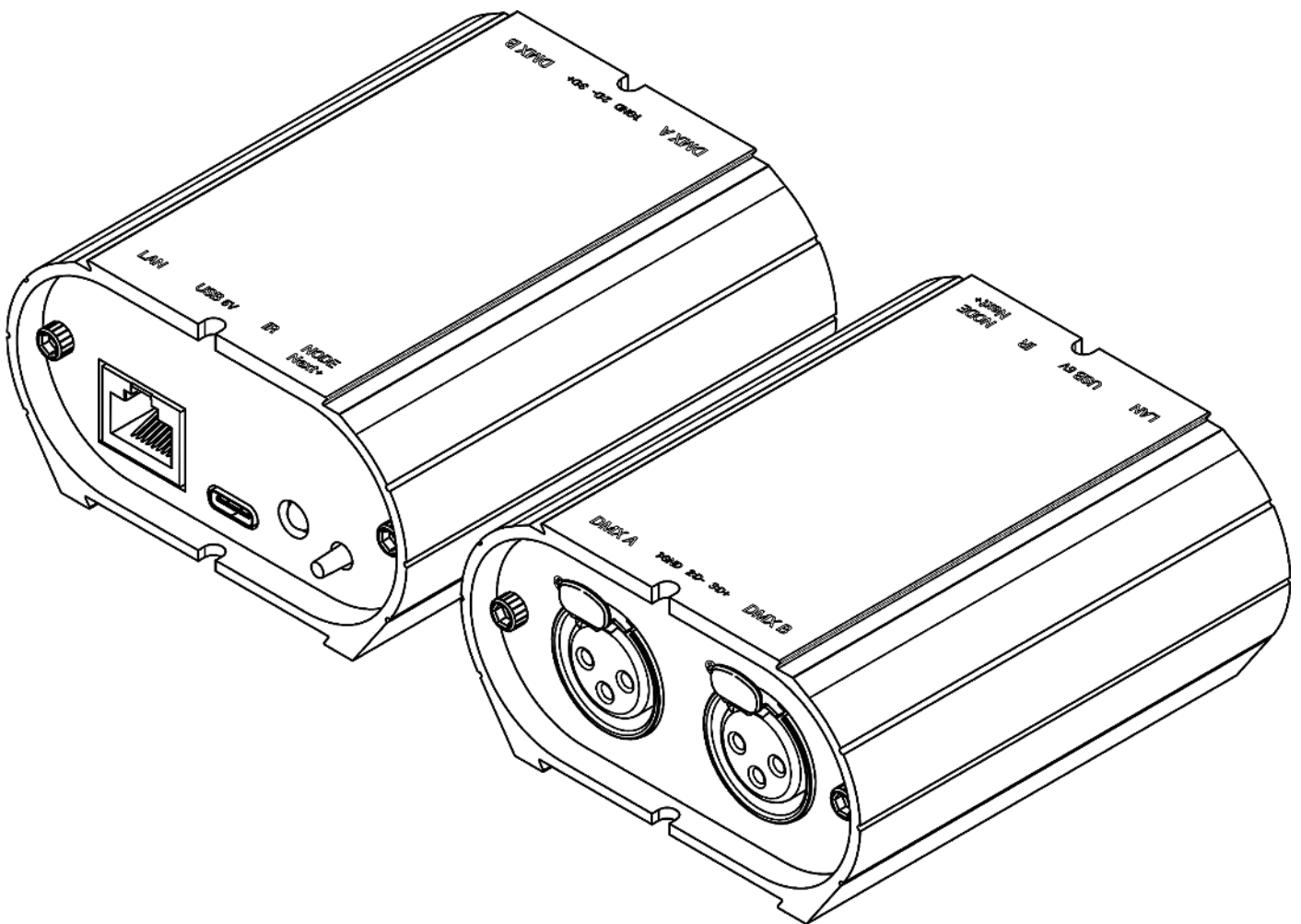

Datasheet &
Quickstart Guide

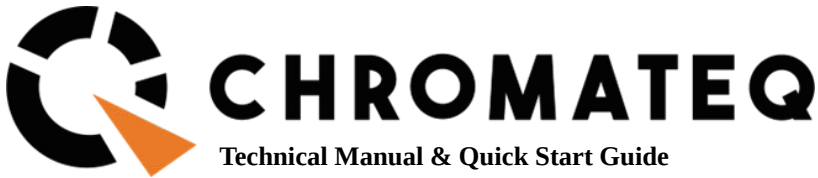

Congratulations on your purchase of a CHROMATEQ controller.

Please read this manual carefully and thoroughly before using the CLUB-E Chromateq.

The information presented here provides a useful introduction to the wide range of features, settings and functions available in this compact and versatile CLUB-E

The CLUB-E Technical Manual is written in English and French.
(Le manuel technique du CLUB-E est rédigé en anglais et en français.)

All products and software are developed and designed in France.

CHROMATEQ SARL

191 Allée de Lauzard 34980 St Gély du Fesc FRANCE VAT: FR18521458034 Siret: 52145803400027 Web & E-mail:
www.chromateq.com Phone: +33 952210755 / +86 13422062209 Whatsapp: +8613422062209 Wechat: Chromateq QQ:
2908265661

Twitter: <https://twitter.com/Chromateq>

Facebook: <https://www.facebook.com/ChromateqCompany/>

YouTube: <https://www.youtube.com/c/chromateq>

Copyright Information and Disclaimer

Copyright © 2021 - CHROMATEQ. All rights reserved.

No part of this publication may be reproduced, distributed or transmitted in any form or by any means whatsoever, including photocopying, recording or other electronic or mechanical methods, without the prior written permission of the publisher, except in the case of brief quotations in criticisms and certain other non-commercial uses permitted by copyright law.

For any request for authorization, write to the publisher at the address above.

Trademark credits

Microsoft and Windows are U.S. registered trademarks of Microsoft Corporations. Art-Net™ - Designed by and Copyright Artistic License Holdings Ltd. All other products mentioned herein may be trademarks of their respective ® companies.

Package Contents

- 1x CLUB-E
- 1x USB cable
- 1x Power supply 9-12V DC (Euro/US socket)
- 1x software download link and technical documentation

Caution: Check the contents of the package and the condition of the interface after unpacking! Contact your supplier if something is missing or is damaged. Do not use the device if it appears to be damaged!

Table des matières

Introduction.....	4
Technical specifications.....	4
Device Features.....	4
Software options.....	5
Housing connectivity	6
Front Panel	6
Rear Panel.....	6
USB drivers installation	7
Multiple USB connections.....	7
Ethernet connection and configuration.....	8
DHCP / IP Static.....	8
DHCP connection.....	8
Static IP connection.....	9
Reset of the IP address.....	9
Connecting to a wifi router.....	9
Standalone mode settings	10
Device configuration	10
IN/OUT tab	10
"Merge DMX In / DMX Out" option.....	11
Art-Net/sACN universe range:.....	12
Options tab	12
Scenes selection and configuration	13
Triggers selection.....	14
Infrared Trigger.....	14
Triggers via Wi-light 2 app and UDP commands.....	14
Advanced trigger options.	15
Restore after power off.....	15
Play in priority.....	15
Save in memory option.....	16
Basic backup.....	17
Save to an internal and external micro SD card.....	17
Save Art-Net or sACN to an external SD card	17
Standalone use.....	18
Switch to standalone mode.....	18
External and USB power supply.....	18
How to use IR Remote.....	18
Previous Remote Control Unit (Before 2022).....	18
Functioning for Interfaces without Mode and older interfaces.....	18
Functioning for Interfaces with Modes.....	19
New Remote Control Unit (2022).....	19
Functioning for Interfaces without Mode and older interfaces.....	19

Functioning for Interfaces with Modes.....	20
Functions descriptions.....	20
IR Codes.....	21
NODE mode setup.....	22
Setup with the software.....	22
Network setup	22
NODE Art-Net or sACN mode.....	22
Setup with the DeviceTool.....	23
Network setup	23
NODE Art-Net or sACN mode.....	23
Setup with a Web Browser.....	24
UDP, Broadcast, Unicast, Multicast.....	24
Reset the default device	25
NODE wiring diagram.....	25
Detecting NODEs on the network	26
Art-Net wiring diagram.....	27
Housing dimensions.....	Bookmark missing
Front panel	Bookmark missing
Back panel.....	Bookmark missing
Tops panel.....	Bookmark missing
Troubleshooting	29

Introduction

CLUB-E is designed for lighting experts, high-profile projects and live shows. It synchronises audio and video timelines, automates sound to light and turns any computer into a powerful lighting control console.

Objectives

The purpose of this technical manual is to develop the options managed by the interface in standalone mode, refer to software manuals.

Technical specifications

Input	USB-C and RJ45 Ethernet (10Mb/s)
DMX outputs	2x512 or 1024 on 3-pin XLR (XLR 5 optional)
DMX mode	2x512, 1024 or 512 In/Out (PC + standalone)
Internal memory capacity	100 ~ 1024 steps
CPU	32-bit processor
Power supply	5V, 0.3A via USB-C
Index of protection	IP22
Dimensions (mm)	H: 45 (1.77 in) / L: 90 (3.54 in) / I: 80 (3.15 in)
Net weight	0.19 Kgs (0.42 lbs)
Gross weight	0.31 Kgs (0.68 lbs)
Power / Consumption	1.5 W
High voltage protection	Yes, fuses and diodes
Case	Anthracite Grey, Brushed Aluminium
Environment of use	Interior
Storage	Store dry
Temperature of use	- 40 to +85 C°
Certifications	CE, RoHS
International guarantee	Yes, 3 years
Compatibility of systems	Windows (7 and higher), MAC OS X (10.13 and higher) and Linux (64 Bits, Debian, Redhat, Archlinux, Raspberry Pi)

Device Features

DMX input	PC , DMX recording, DMX trigger
Standalone mode	2x512 (splitter), 1024, 512 outputs, 16-bit DMX channels
Art-Net, sACN	Yes, PC
NODE Art-Net sACN	Art-Net and sACN to DMX decoder, 2x512 channels (2 DMX universe)

Supported modes	UDP, Broadcast, Unicast, Multicast, fixed IP, DHCP
Infrared receiver	Infrared remote control (available as an option)
Infrared options	10 scene selections, speed, intensity Main dimension and next scene
Communication UDP	Ethernet protocol (UDP) with a list of possible commands
Compatibility	8 and 16-bit DMX devices
RDM (Remote Device Management, bi-directional DMX communication)	Yes, with Pro DMX 2 only
Wi-Light 2	Yes
WEB control with Wi-Light 2	No

Software options

Player Software	2x512 DMX channels + Stand alone mode, mode Live Board
Pro Software	2x512 channels, normal mode, 30 min audio and video timeline loop
Pixel mapping software	8x512 Art-Net, 128x128 or 16384 Pixels
Studio DMX 3D viewer	Full Mode
Art-Net sent from the PC	2 Universe (DMX + Art-Net)
Wi-Light 2 App	Controls Player, Pro and Pixxem software over a local WiFi network
Free software updates	yes

Housing connectivity

Front Panel

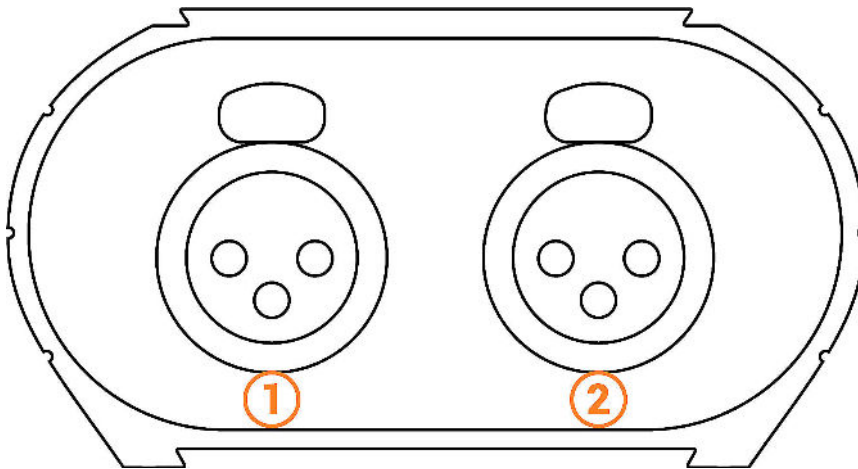

- 1 - Output DMX A,
- 2 - Input / Output DMX B

XLR Connector 3 pins

- 1: Ground
- 2: Data -
- 3: Data +

Rear Panel

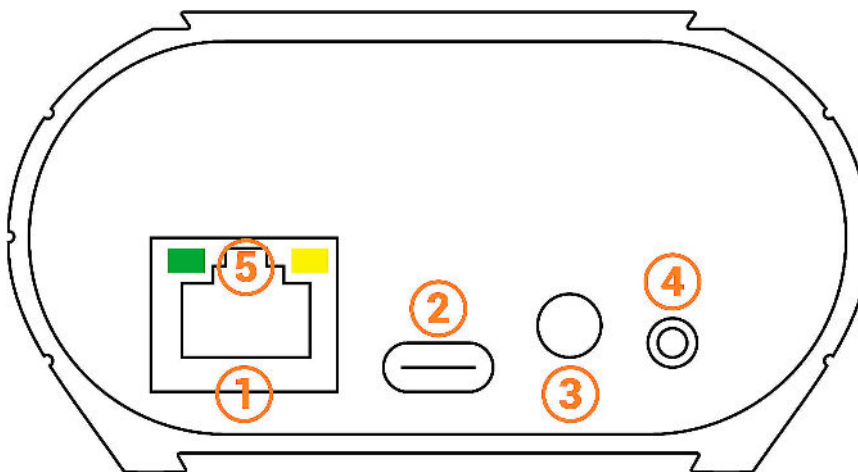

- 1 - RJ45, Network (LAN) connection
- 2 - USB-C, power connector (5V. DC, 0.3A)
- 3 - Infra-red receiver LED, optional
- 4 - Modes selector (5 s.) Art-Net or sACN
- 5 - LEDs signals : green (G) et Yellow (Y)

LED signal correspondence

G on + Y off	No signals
G fast blink + Y off	USB signal
G on + Y fast blink	Ethernet signal
G slow blink + Y off	Stand Alone DMX
G on + Y slow blink x1	NODE Mode converter Art-Net to DMX
G on + Y slow blink x2	NODE Mode converter sACN to DMX

USB drivers installation

Install USB drivers to communicate with the device and change settings.
Installation of USB drivers is required only for Windows at the end of installation.
Drivers for Mac and Linux systems are installed automatically.

USB drivers verification :

In the Windows Device Manager. Check that the device icon is visible in "USB Bus Controllers".

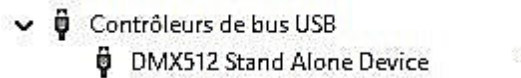

If drivers are not installed, the Windows Device Manager lists a device with a yellow warning.

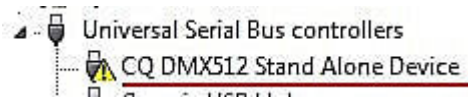

On Mac OS, simply check the USB device tree to view "DMX 512 Stand Alone Device". On Linux, use the "lsusb" command to view "DMX 512 Stand Alone Device" as a list.

After control software installation and USB drivers

- Connect the device with the USB cable.
- Start the DEVICETOOL and select "Open USB Device" to change the settings.
- Start the software and menu "Tools", then "Options" to change the settings in the "Device" page.

All connected and detected devices are listed.

Multiple USB connections

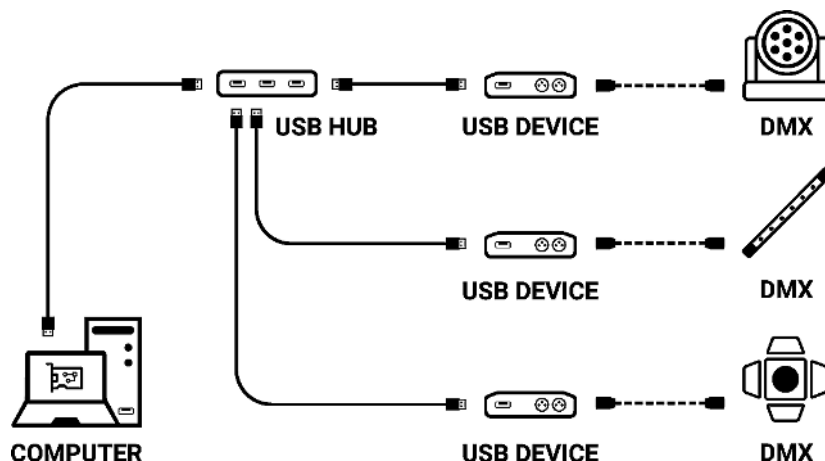

Ethernet connection and configuration

Establish Ethernet communication with the device to change its settings in the software options window or via the DEVICETOOL.

It can be done in several ways: Live, via an IP Switch or a Wifi router. The device is in DHCP mode by default.

Initial steps required

- Connect the device to the LAN or computer via an RJ45 Ethernet cable.
- Power the device via USB cable (5V DC, 0.3A).
- Connect the computer to the same network (LAN) or interface via an RJ45 Ethernet cable.

DHCP / IP Static

In DHCP mode, without responses from a DHCP server after a short time, the interface will use static IP mode with its default IP address and wait for the next DHCP request to use DHCP mode. It will therefore always be possible to connect directly to the computer in static IP MODE. The device is in DHCP mode by default.

DHCP connection

DHCP mode, allows you to communicate with devices through a DHCP server that automatically assigns and manages the IP addresses of each device. The DHCP server can be of Switch IP or Router type or other.

The device is in DHCP mode by default.

It is detected by software automatically when the computer is also connected in DHCP to the same network or with a static IP address of the same range.

DHCP benefit is that the DHCP server automatically manages the IP addresses of connected devices. So it is not necessary to know exactly the IP of your device to connect to it. However, IPs are regularly modified and can make the installation less reliable.

Setting up the DHCP connection

- After the required initial steps are completed.
- If the device is in DHCP mode (default mode).
- Also configure the computer in DHCP mode.
- Start the software or DEVICETOOL by selecting "Open Ethernet Device"

Static IP connection

Static IP mode, allows you to communicate directly with an interface without necessarily going through another device such as IP switch or router or access point. It is also used on LANs without DHCP server.

Static IP mode also allows you to freeze a network configuration and provides better stability to installations designed with multiple devices thanks to an IP switch or routers.

The default static values of the device are:

IP address: 192.168.0.5

Subnet mask: 255.255.255.0

Setting up the Static IP connection

- After the required initial steps are completed.
- If the device is in Static IP mode.
- Set the IP address of the computer to an identical IP address range of type 192.168.0.x. With "x" different than 5 to avoid identical IP conflicts on the network.
- Also set the subnet mask to 255.255.255.0.
- Start the software or application.

In an identical IP address range, the device will be recognized when software starts.

Reset of the IP address

If there is a default IP address not found, use the USB connection and software settings tools to check or change the device IP address.

Connecting to a wifi router

If the device's RJ45 port allows a wired connection to a local network, it is also possible to connect to it via WIFI via a WIFI router.

The illustration below is an example of a configuration using a third-party mini WiFi router to allow a wireless connection. Other descriptions of these routers can be "hotspot", "hub", "dongle", "bridge", "repeater", etc.

Note: Connect multiple devices to the WiFi router or extend the available RJ45 ports with a Switch IP.

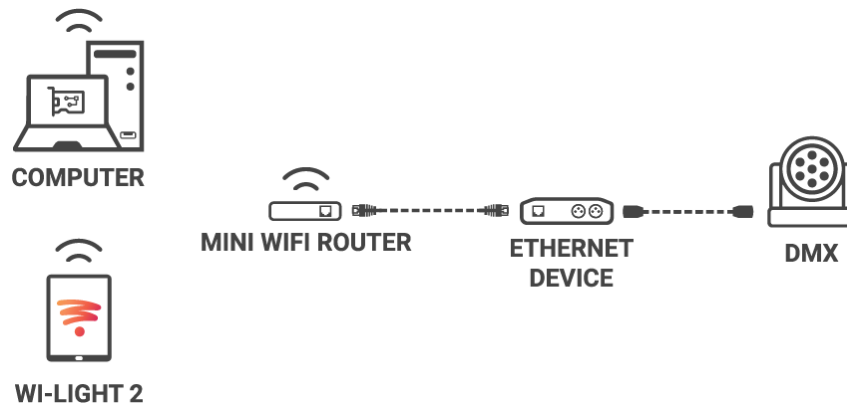

Implementation of the WIFI network:

- Set up the WiFi router as a Hotspot to create a new access point.
- Or configure the WiFi router as “Bridge” or repeater to join an existing network.
- It is possible to configure the router in Static IP or DHCP.
- In DHP (default mode of a router) IP addresses are dynamically assigned on the network by the DHCP server.
- After configuring the router, connect the RJ45 ports and configure the device in DHCP or static IP mode.
- Once the device is connected to the router, it can be used and visible on the network.

Standalone mode settings

In standalone mode of the control software,  configure the device according to the available options then select and configure the triggers of scenes to be written in memory.

Device configuration

IN/OUT tab

Select a DMX input/Output configuration of the interface from the drop-down menu

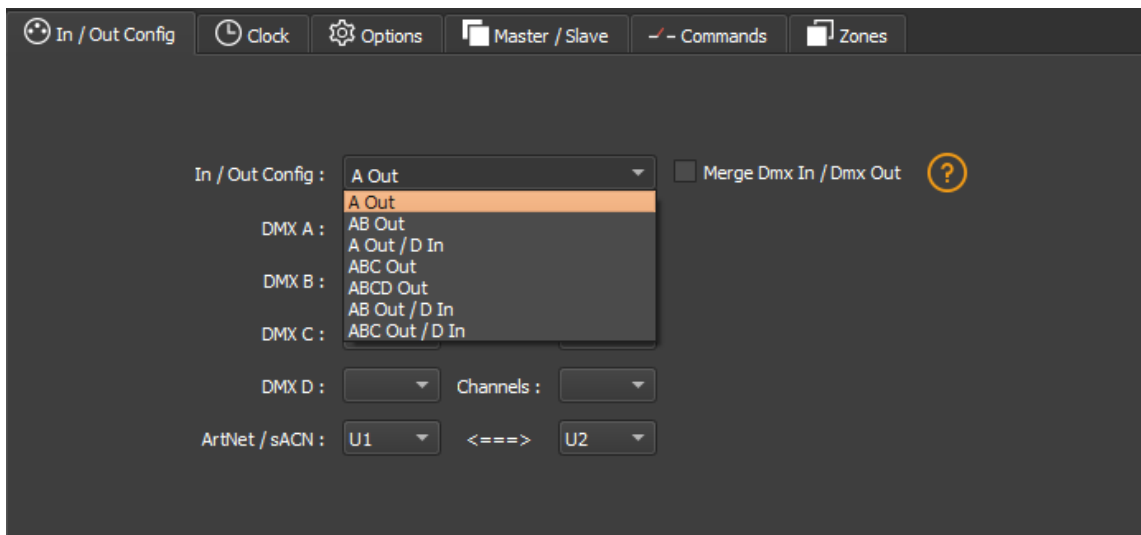

Available configurations will be displayed depending on the connected device depending on whether it has 1.2 or 4 DMX lines.

- **A OUT** - Assigns 1 output universe on the DMX line(s), for devices that have more than 1 DMX lines duplicate the universe on each.
- **AB OUT** - Assigns 1 different output universe on 2 DMX lines, for devices that have 4 DMX lines duplicates the first 2 lines on the next 2 lines.
- **A OUT/B or D IN** - Assigns 1 output universe on the first line(s) and uses the last DMX line as DMX input.
- **ABC OUT** - Assigns 1 different universe output on the first 3 DMX lines.
- **ABCD OUT** - Assigns 1 different universe output on 4 DMX lines.
- **AB OUT / D IN** - Assigns 1 different output universe on the first 2 lines and uses the last DMX line as DMX input.
- **ABC OUT / D IN** - Assigns 1 different output universe on the first 3 lines and uses the last DMX line as DMX input.

"Merge DMX In / DMX Out" option

Available with interfaces with more than 2 or 4 DMX lines.

Enable the option to re-inject line configured as an input (IN) to the line(s) configured in DMX outputs and thus merge them.

The merged DMX levels are compared and the highest is retained. We are talking about HTP (Highest Takes Priority).

Maintain manual control on some circuits with an external DMX console.

Create a multi-zone system by merging several cascading interfaces to obtain only one common DMX line.

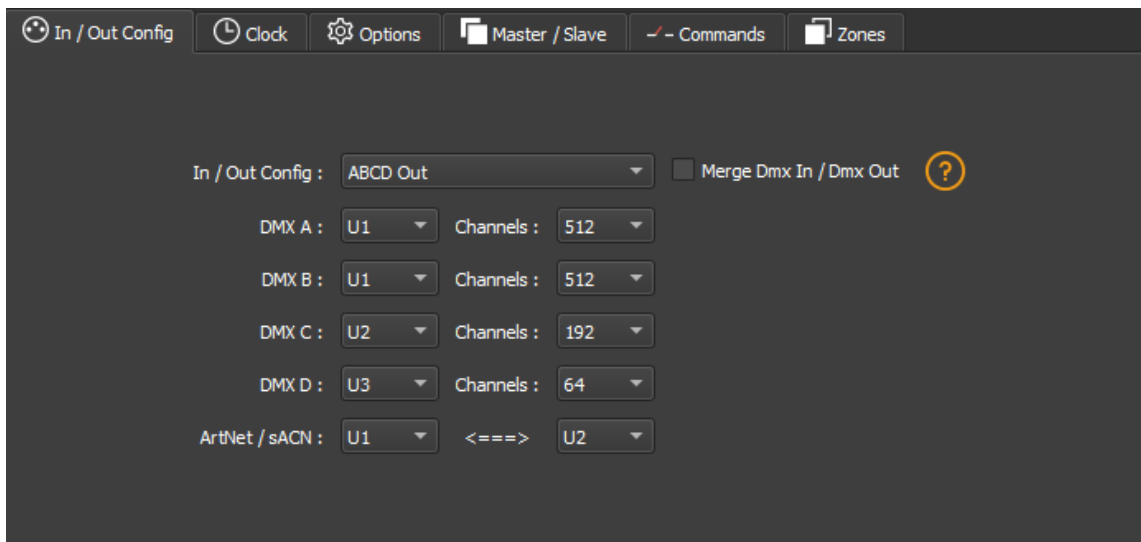

Assign any universe of the software to any DMX line assigned to output, choosing line by line (U1, U2...).

Optimize the size of shows saved in memory by reducing the number of circuits per universe depending on the channels used.

Example: If 150 channels are used in the show, select only the nearest higher value, here 192.

Art-Net/sACN universe range:

Define the starting universe and the finish universe to write in memory on an external SD card for an Art-Net/sACN show.

Cf: "Saving Art-Net or sACN to an external SD card"

Options tab

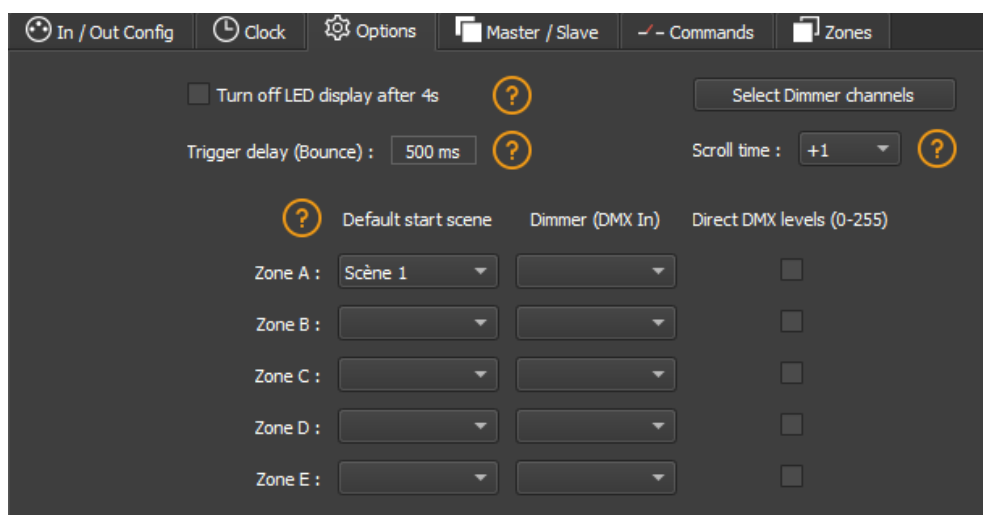

For devices with an LED display, turn it off after 4 seconds of inactivity by checking the option.

Select a default scene to play automatically after the interface is turned on (with USB or external power supply). For multi-zones devices it is possible to set a default scene for each area.

Note: The selected default start scene loses its priority if another scene uses the "Restore if power off" option.

Cf: "Advanced trigger options"

Configure the "Select Dimmer channels" option to select separately the Dimmer or RGBW light intensity channels that will be controlled directly by Dimmer mode, dry contacts or via the infrared remote control.

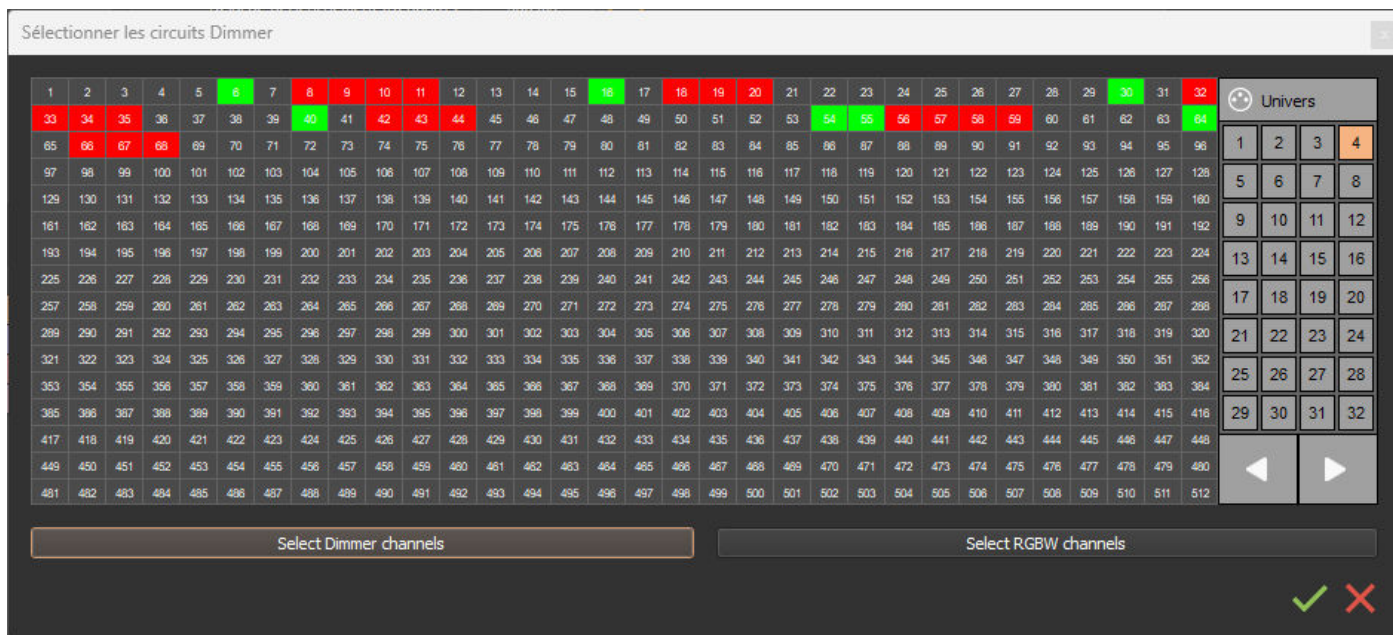

Scenes selection and configuration

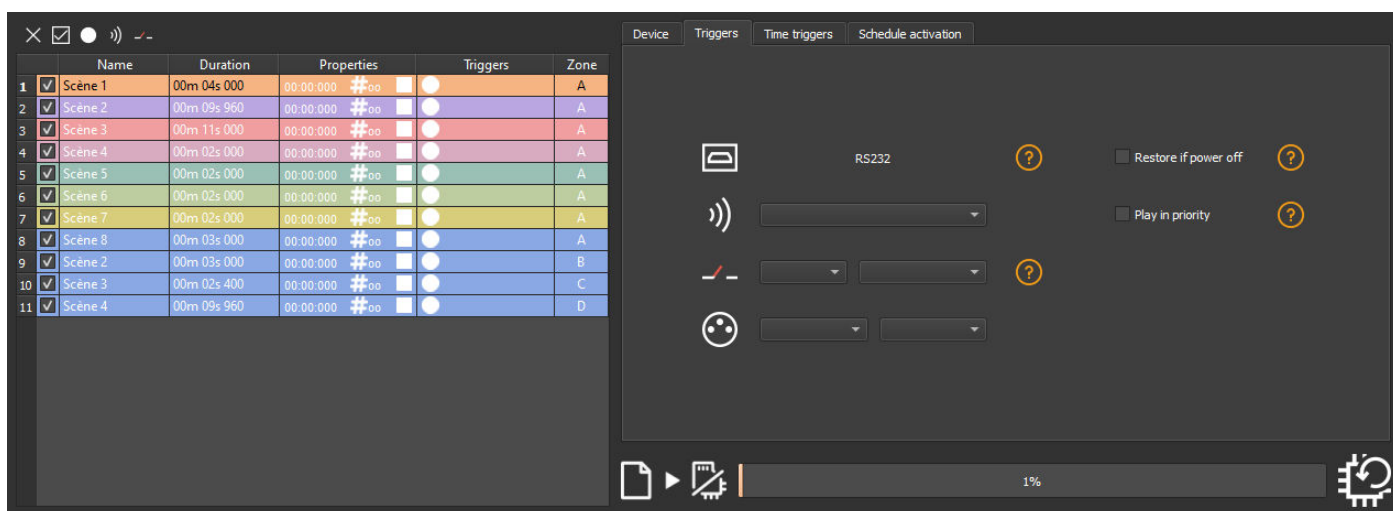

Check to select the scenes to write in memory and assign triggers from those available by your device.

Triggers selection

In the "Triggers" tab, select and assign different types of triggers.

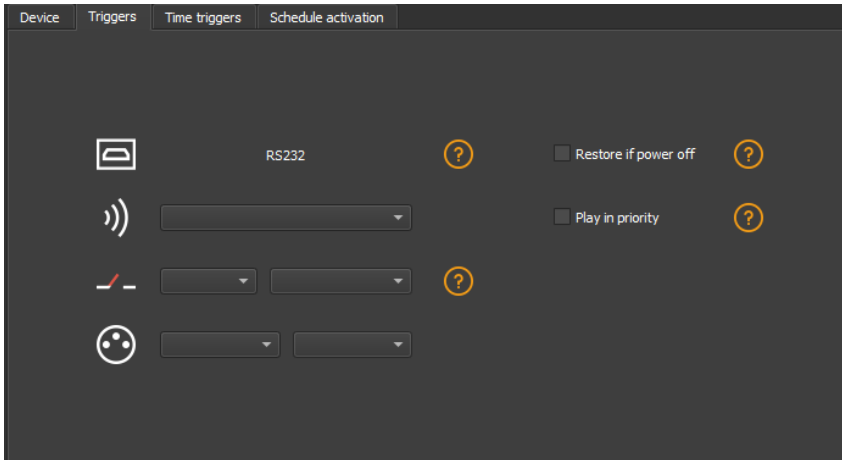

Infrared Trigger

For devices that do not have this trigger option an Infrared kit is available containing an IR receiver and a remote control.

Cf: *"use of the remote control by infrared"*

Select a scene from the list and assign it a remote control button from the 15 available buttons.

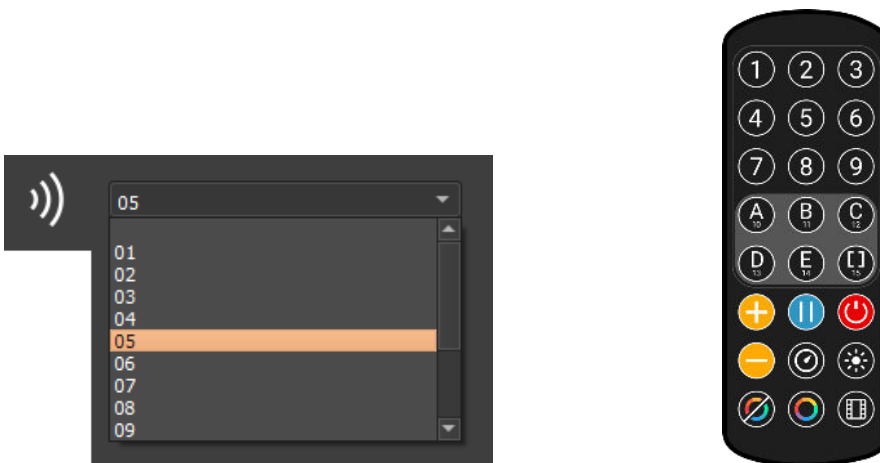

Automatically assign buttons to all scenes in the list by clicking the Infrared icon on the scene list toolbar.

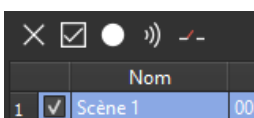

Triggers via Wi-light 2 app and UDP commands

When connected to a local network with a WIFI access point, it is possible to trigger and control the interface with the Wi-Light 2 app for Android and iOS when it runs in standalone mode. This

local mode is also available on the internet with the Web Remote option.

Each device, interface and mobile, must be connected to the same access point in DHCP (recommended) or fixed IP mode. The application will then detect the interface and display the list of scenes and other possible controls and commands. The Web Remote control option requires you to create a user account and save your interfaces locally first. Please refer to the Wi-Light 2 manual to use this mode.

The Wi-Light 2 app uses an open protocol for developers with standard communication based on simple UDP commands.

Third-party software can establish UDP communication with the software/interface and control it using predefined JSON commands. Option only available with interfaces with an Ethernet port. (see "Communication Development Kit User Manual")

Advanced trigger options.

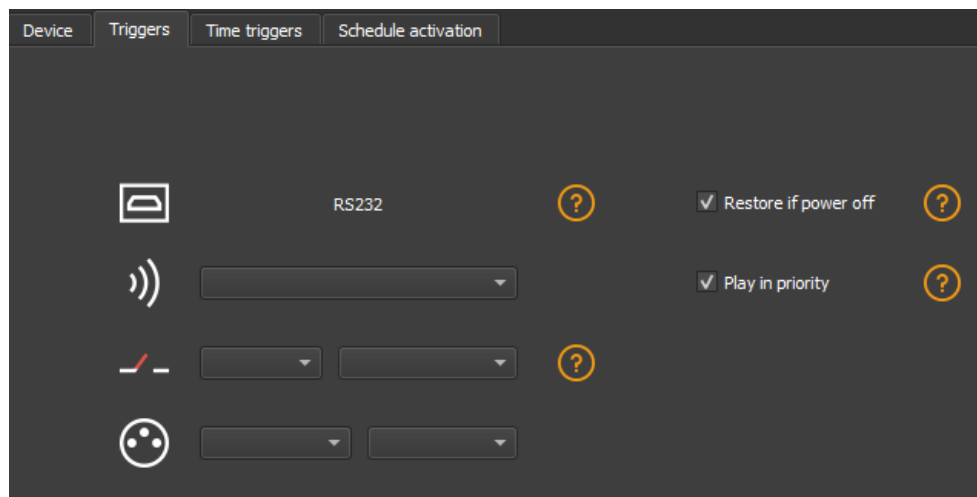

Restore after power off

By checking this option in the "Triggers" tab, the selected scene takes priority on the boot scene (see "Options tab") when the power supply is restored.

If all scenes have the option checked, the last active scene is replayed.

Play in priority

By checking this option in the "Triggers" tab, the selected scene plays continuously until its end, without taking into account other triggers, except for time triggers and physical buttons on the device.

Save in memory option

Check scenes that need to be saved in memory.

	Name	Duration	Properties	Triggers	Zone
1	<input checked="" type="checkbox"/> Scene 1	00m 14s 400	00:05:000 #00		A
2	<input checked="" type="checkbox"/> Scene 3	00m 00s 480	00:03:000 #00		A
3	<input checked="" type="checkbox"/> Scene 4	00m 05s 720	00:05:000 #1		A
4	<input type="checkbox"/> Scene 5	00m 18s 000	00:07:000 #1		A
5	<input type="checkbox"/> Scene 6	00m 05s 000	00:00:000 #00		A
6	<input checked="" type="checkbox"/> Scene 6_copy_1	00m 05s 000	00:00:000 #00		A
7	<input type="checkbox"/> Scene 6_copy_2	00m 07s 000	00:00:000 #00		A
8	<input type="checkbox"/> Scene 6_copy_3	00m 07s 000	00:00:000 #00		A
9	<input type="checkbox"/> Scene 6_copy_4	00m 07s 000	00:00:000 #00		A
10	<input type="checkbox"/> Scene 6_copy_5	00m 07s 000	00:00:000 #00		A
11	<input type="checkbox"/> Scene 6_copy_6	00m 07s 000	00:00:000 #00		A
12	<input type="checkbox"/> Scene 6_copy_7	00m 07s 000	00:00:000 #00		A
13	<input type="checkbox"/> Scene 6_copy_8	00m 07s 000	00:00:000 #00		A
14	<input type="checkbox"/> Scene 6_copy_9	00m 07s 000	00:00:000 #00		A
15	<input type="checkbox"/> Scene 16	00m 03s 000	00:05:000 #3		A
16	<input type="checkbox"/> Scene 17	00m 08s 000	00:00:000 #2		A
17	<input type="checkbox"/> Scene 18	00m 03s 200	00:00:000 #40		A
18	<input type="checkbox"/> Scene 19	00m 13s 000	00:00:000 #2		A
19	<input type="checkbox"/> Scene 20	00m 04s 000	00:00:000 #2		A
20	<input type="checkbox"/> Scene 21	00m 03s 500	00:00:000 #2		A

Click on the "Write in Memory" button

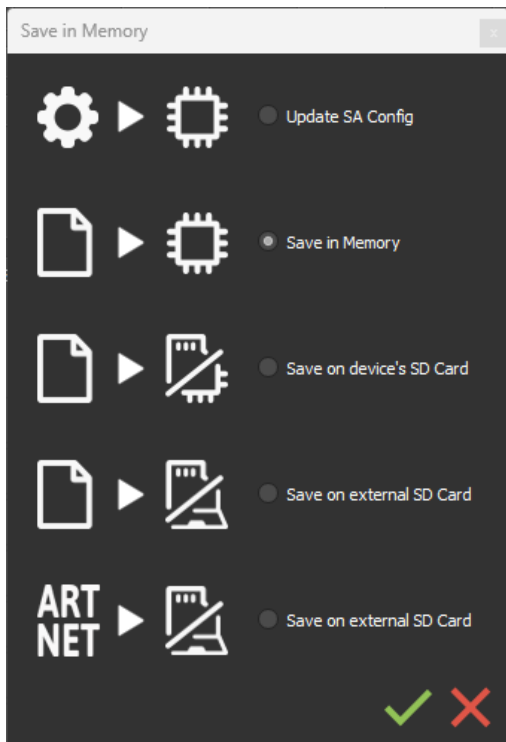

Select the desired option in the Scenes Write window.

Basic backup

Write standalone configuration: Change only certain settings in the configuration of a show already written in memory. Reduces backup time.

Write to Memory: Default backup in the internal memory of the device.

Save to an internal and external micro SD card

For devices with a micro SD port.

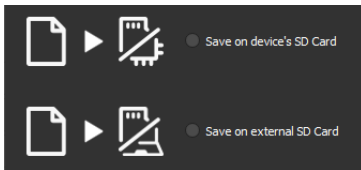

Save scenes to a micro SD card (Class 10) installed in the device's SD card reader or in the computer drive. The card must be CLASS 10, formatted in FAT or FAT 32 with a maximum capacity of 256 GB. It is recommended to use the largest allocation unit size available when formatting.

Write to the SD card of the device: SD card installed in the interface drive

Write to an external SD card: SD card connected to the computer

Note: Save to the root directory of the SD card.

Save Art-Net or sACN to an external SD card

For devices with a micro SD port and an Ethernet port.

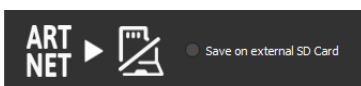

Art-Net - Write to an external SD card: Save up to 8 universes only on micro SD to render an Art-Net or sACN show independently.

Set the universe range in the IN/OUT config tab. Cf:

Pre-commissioning verification:

Connecting the RJ45 cable before power on.

Connection to the local network. Cf: "Ether Ethernet connection and configuration"

Configuring the device in Art-net or sACN mode via the software or DeviceTool.

Note: Once in Art-Net (Ar) or sACN (AC) mode, the interface is no longer visible on the local network.

In Art-Net the interface will use Broadcast to play the show on the network.

In sACN the interface will use the Multicast to play the show on the network.

Standalone use

Switch to standalone mode

The interface switches to standalone mode automatically after 5 seconds after power on and if no software connection is made.

External and USB power supply

The external power supply is only used for "Autonomous" mode. But it is possible to connect a USB cable and power supply at the same time, even if this configuration is not recommended. If a USB cable is connected to the interface when running in standalone mode, the device will detect a possible connection to a computer but this will not affect the scenes that play.

How to use IR Remote

Infrared Remote triggers work in Stand Alone and in Live mode when "Get Stand Alone Triggers" is checked in software option window, at the bottom of "Device" section.

Get Stand Alone triggers

Previous Remote Control Unit (Before 2022)

Functioning for Interfaces without Mode and older interfaces.

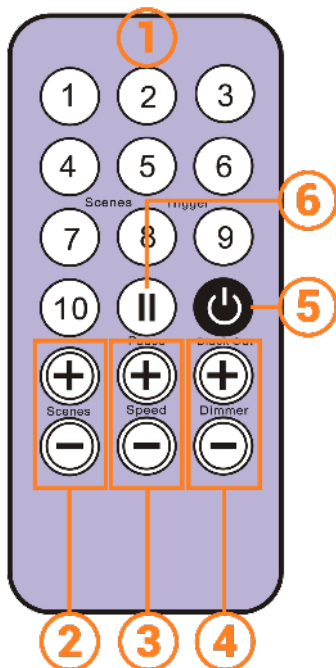

1. **Scene trigger buttons** (1 to 10) assigned via the software.
2. **Scene selector**, next or previous.
3. **Speed value**, increase & decrease
4. **Dimmer value**, increase & decrease
5. **Blackout:** Stops the current scene and plays the scene 00. All DMX levels are set to zero.
6. **Pause:** Freezes the current scene in its state

Functioning for Interfaces with Modes

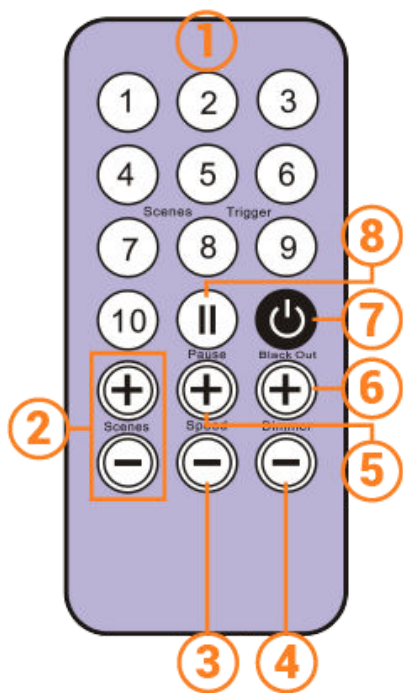

1. **Scene trigger buttons** (1 to 10) assigned via the software
2. **Increase or decrease** the value of the selected mode:
Scene +/-, Dimmer +/-, Speed +/-, Color +/-.
3. **Color mode**
4. **Scene mode**
5. **Dimmer mode**
6. **Speed mode**
7. **Blackout:** Stops the current scene and plays the scene 00.
All DMX levels are set to zero.
8. **Pause:** Freezes the current scene in its state.

New Remote Control Unit (2022)

Functioning for Interfaces without Mode and older interfaces.



1. **Scene trigger buttons** (1 to 10) assigned via the software.
2. **Scene selector**, next or previous.
3. **Speed value** decrease
4. **Speed value** increase
5. **Dimmer value** decrease
6. **Dimmer value** increase
7. **Blackout:** Stops the current scene and plays the scene 00. All DMX levels are set to zero.
8. **Pause:** Freezes the current scene in its state

Functioning for Interfaces with Modes



1. **Scene trigger buttons** (1 to 15) assigned via the software Trigger 1 to 15 with 1 Zone. Trigger 1 to 9 with several Zone.
2. **5 Control Zones** available: A, B, C, D, E and Global Zone: [] to trigger each Zone in the same time.
3. **Increase or decrease** the value of the selected mode: Scene +/-, Dimmer +/-, Speed +/-, Color +/-.
4. **Release Color mode**
5. **Color mode**
6. **Scene mode**
7. **Dimmer mode**
8. **Speed mode**
9. **Blackout:** Stops the current scene and plays the scene 00. All DMX levels are set to zero.
10. **Pause:** Freezes the current scene in its state.

Functions descriptions

Scene +/-: Each push selects the next or previous scene of the current Zone. Scene are play immediately.

Master Dimmer: Increases or decreases the RGB, CMY and dimmer channels of the current zone. The CMY, RGB, Dimmer channels are defined in the Profile of the fixture and the stand-alone mode.

Scene Speed: Increases or decreases the speed of the current scene in the current zone. A different speed can be chosen separately for each scene.

Zones: Choose a Zone (A,B,C,D,E or Global []). Then select a scene or mode to trig in the selected zone.

Modes: Select a Mode from Speed, Dimmer, Color or Scenes, then use +/- to change values.

IR Codes

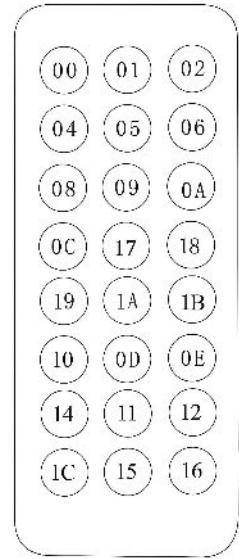
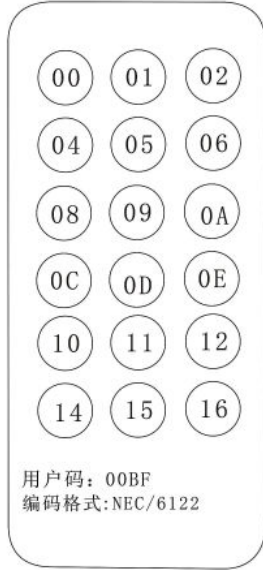
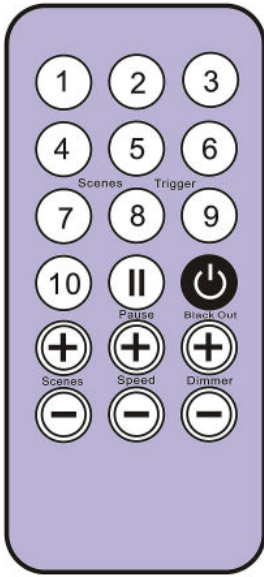

NODE mode setup

Setup with the software

Network setup

Access the device options window:



In the "Ethernet" tab, check "DHCP" to put the device in DHCP mode and apply.

To put the device in static IP mode, uncheck "DHCP" and enter the IP address, subnet mask, gateway, and name, then apply.

NODE Art-Net or sACN mode

The device's Node mode makes it possible to convert Art-Net and sACN signals to DMX.

In the Node part, select Node Art-Net to change the settings you want.

It is possible to configure names with "Short Name" and "Long Name".

It is possible to change the DMX ports or outputs of the Node by modifying the "SubNet" and "DMX Universe", and then apply.

Select Node sACN to choose DMX and applied Universes.

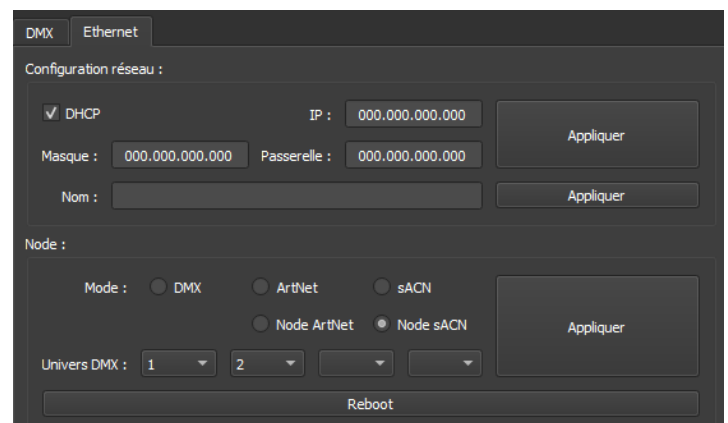
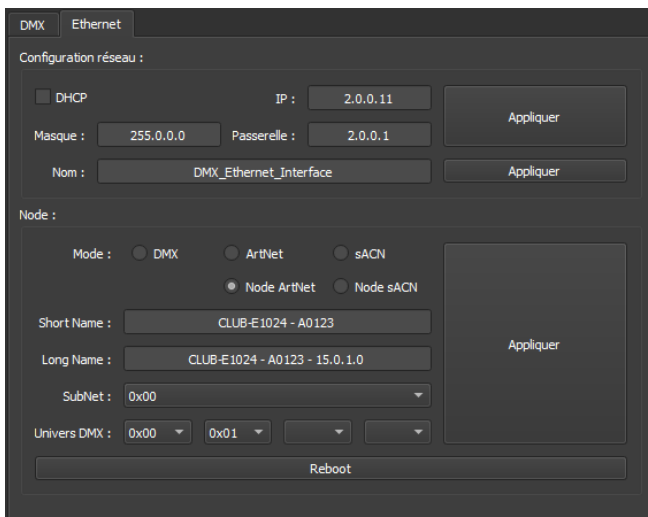

Press "Apply" to take into account the new settings.

To use the device in the selected mode, you must restart the device after configuration by unplugging it from the power supply.

It is also possible to switch between Art-Net and sACN mode with long support (5s.) on the Device Mode button and following the network configuration of the device.

Setup with the DeviceTool

Network setup

Open the device via USB or Ethernet with the option "Open USB Device" or Open "Ethernet Device". Select the "Network" tab.

In the "Ethernet" tab, check "DHCP" to put the device in "DHCP" mode and apply.

To put the device in static IP mode, uncheck DHCP and enter the IP address, subnet mask, gateway, and name, then apply.

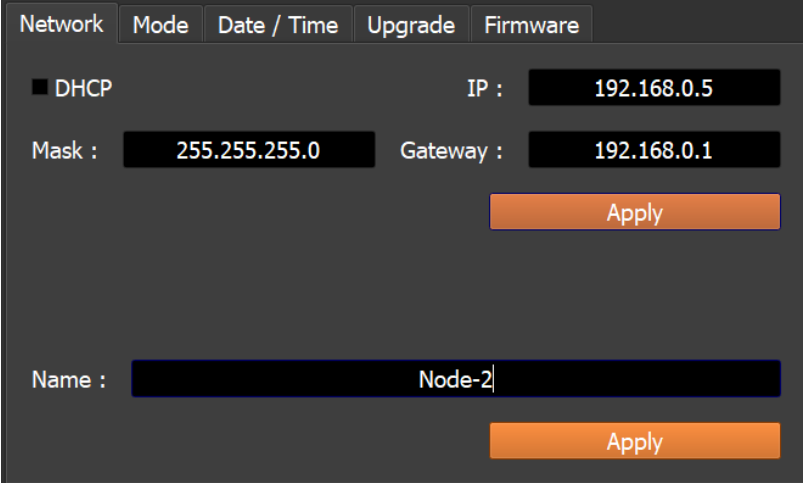

The screenshot shows the "Network" configuration screen in the DeviceTool. At the top, there are five tabs: "Network", "Mode", "Date / Time", "Upgrade", and "Firmware". The "Network" tab is selected. Below the tabs, there is a "DHCP" checkbox which is currently unchecked. To the right of the checkbox, the "IP" field is set to "192.168.0.5". Below the IP field, the "Mask" field is set to "255.255.255.0" and the "Gateway" field is set to "192.168.0.1". There are two orange "Apply" buttons: one below the IP, Mask, and Gateway fields, and another below the "Name" field. The "Name" field is set to "Node-2".

NODE Art-Net or sACN mode

The device's Node mode makes it possible to convert Art-Net and sACN signals to DMX.

Open the device via USB or Ethernet with the option "Open USB Device" or Open "Ethernet Device". Select the "Fashion" tab.

Select Node Art-Net to change the desired settings.

It is possible to configure names with "Short Name" and "Long Name".

It is possible to change the DMX ports or outputs of the Node by modifying the "SubNet" and "DMX Universe", and then apply.

Select Node sACN to choose DMX and applied Universes.

Press "Apply" to take into account the new settings.

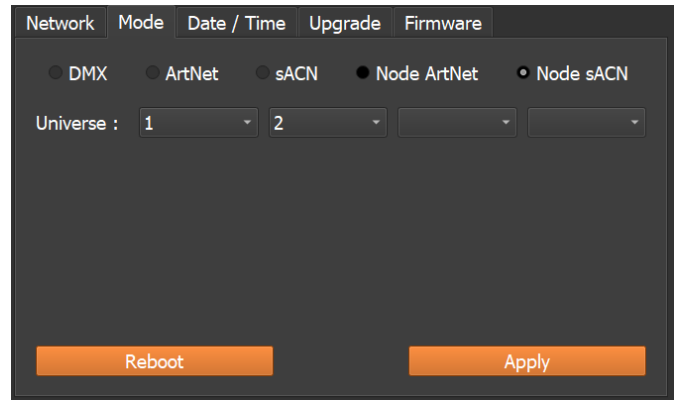
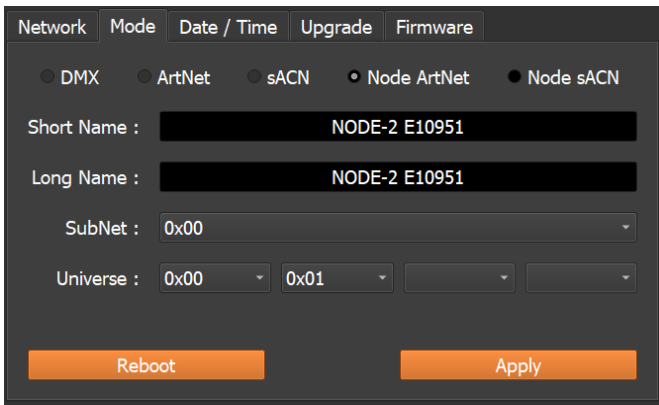

To use the device in the selected mode, you must restart the device after configuration by unplugging it from the power supply.

It is also possible to switch between Art-Net and sACN mode with long support (5s.) on the Device Mode button and following the network configuration of the device.

Setup with a Web Browser

This feature is not currently available.

UDP, Broadcast, Unicast, Multicast

Art-Net and sACN are communication protocols based on the UDP/IP standard. These 2 protocols integrate DMX frames into Ethernet frames allowing simpler and more convenient wiring with the use of IP switches or WIFI terminals.

Several DMX lines can be encapsulated in an Ethernet frame and therefore reduce wiring to 1 single Ethernet line for X DMX lines.

Art-Net network data is transmitted in broadcast or unicast mode.

Unicast is preferable when using multiple devices on the network and when managing more than 10 DMX universes.

sACN network data is transmitted in Unicast and Multicast.

Reset the default device

To restore the default values and reset your device, reconfigure the device via USB or Ethernet with the software or DEVICETOOL or application and restart it to take into account the new mode and settings.

It is also possible to change mode directly on the device with a 5 second long press on the mode button.

NODE wiring diagram

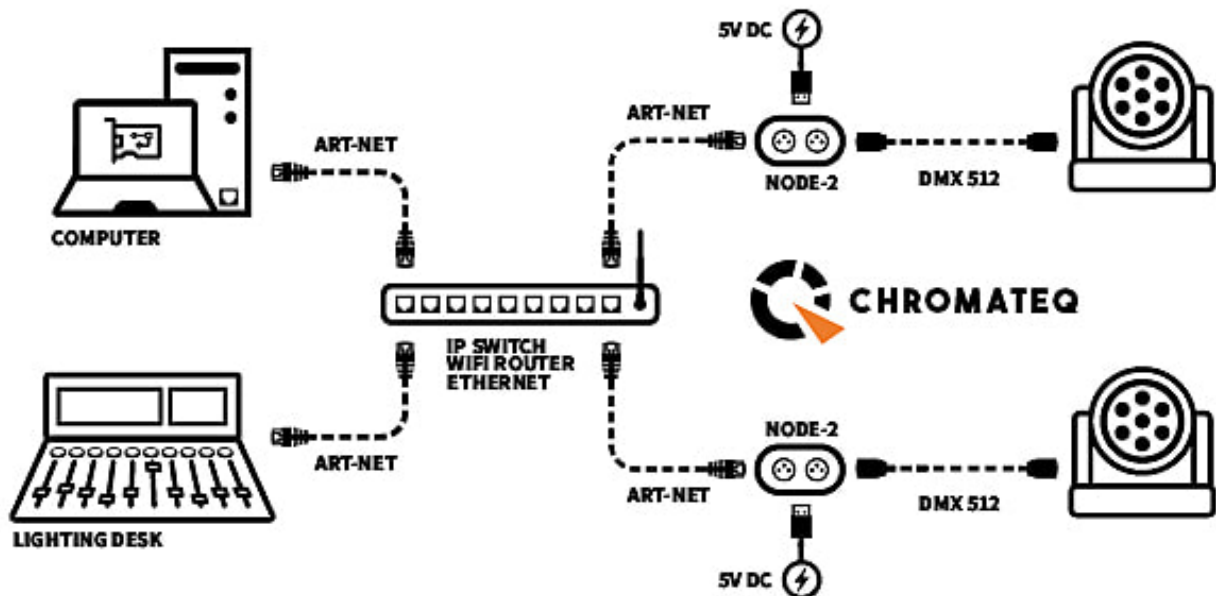

Detecting NODEs on the network

It is possible to connect multiple devices to the same network in order to multiply the DMX output universes.

Audit of previous steps

- Assigning IP addresses and subnet masks.
- Configuring devices via the software or DeviceTool.
- Connecting devices to the network.
- Powering devices.

If the steps have been followed, the devices are visible on the network by the software or by other devices compatible with Art-Net frames.

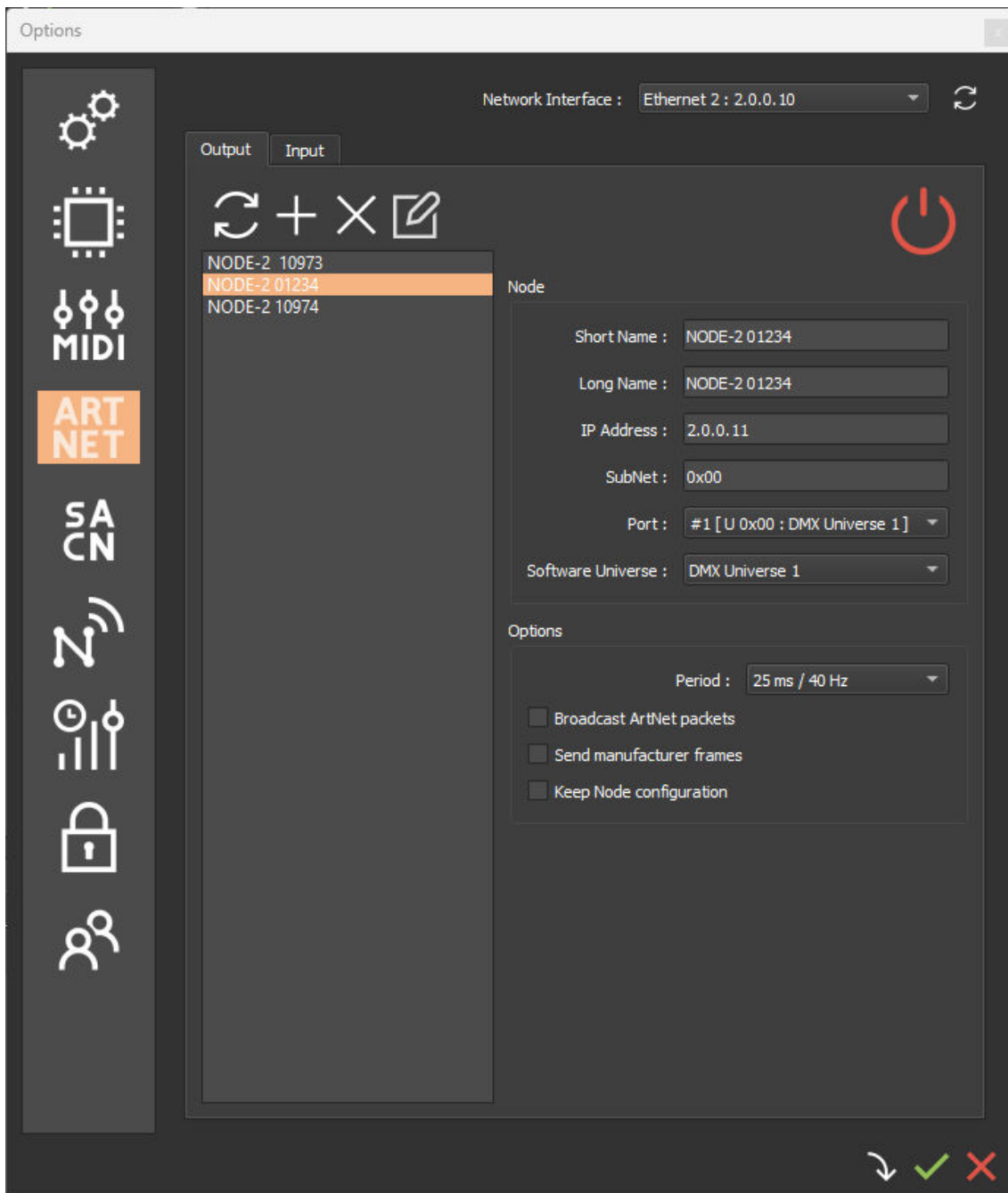

Art-Net wiring diagram

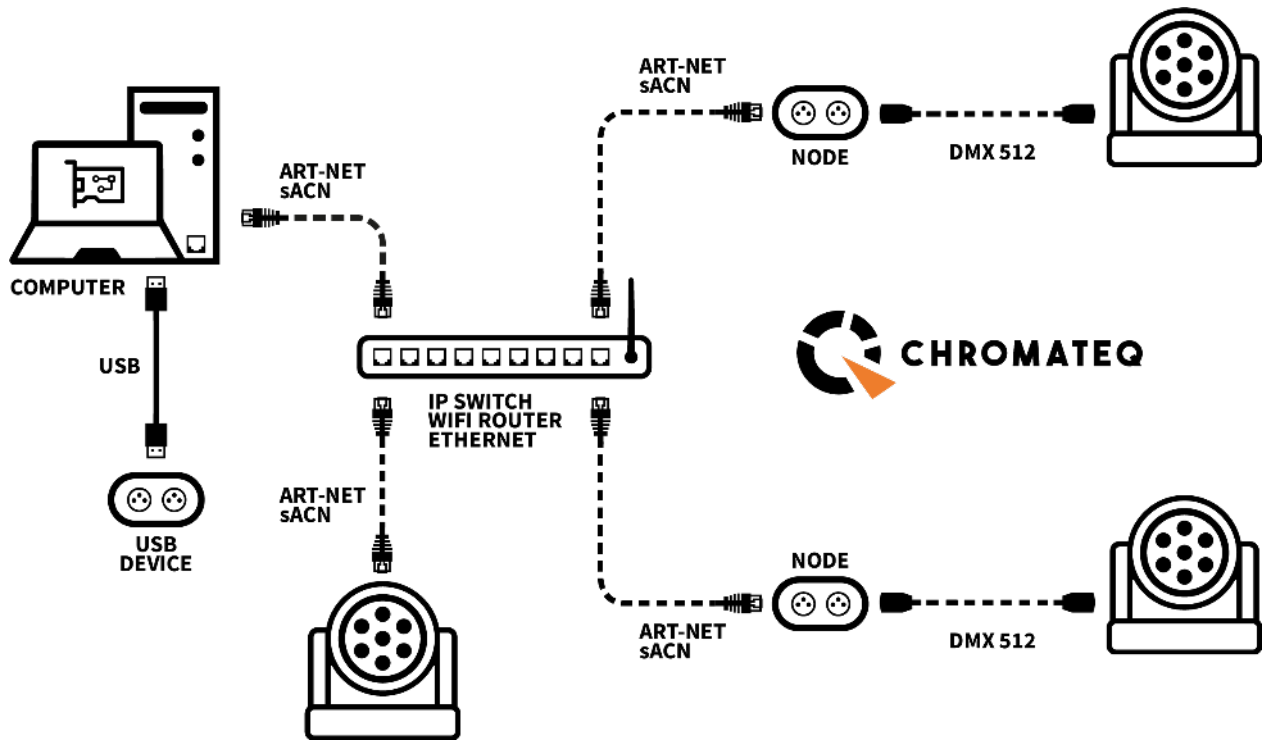

Housing dimensions

Front panel

Dimensions in mm/in.

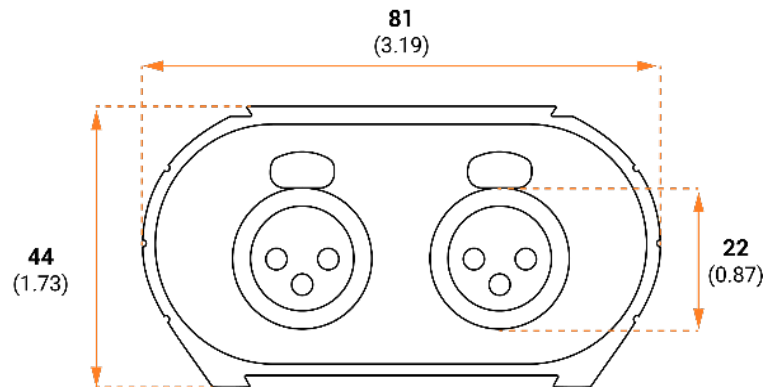

Back panel

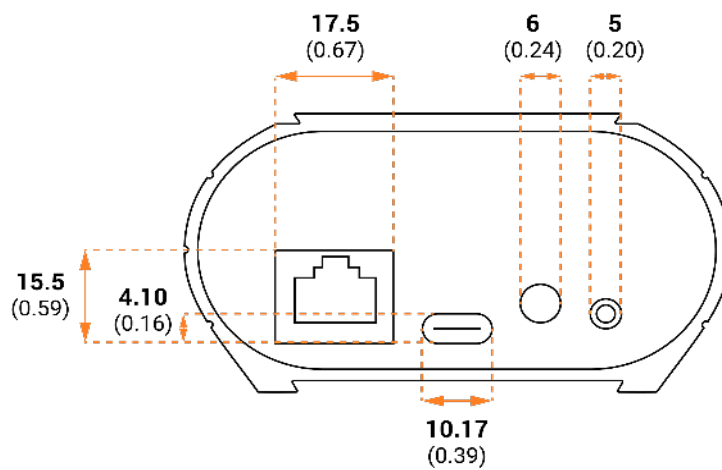

Tops panel

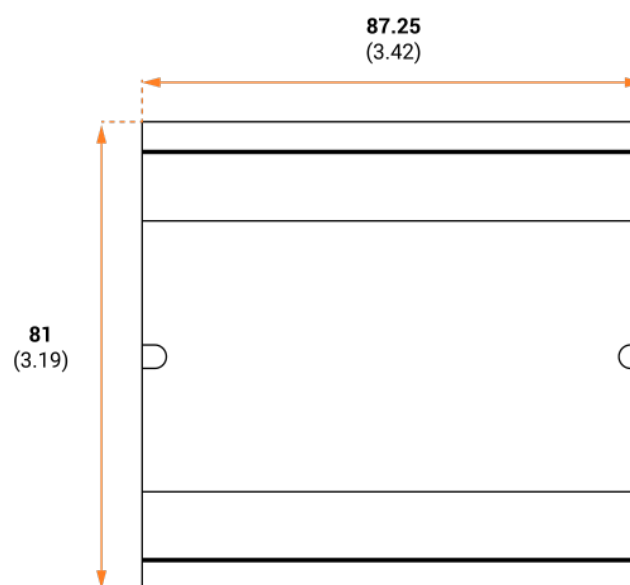

Troubleshooting

The device is not detected by the DeviceTool or USB software.	Unplug to restart the device.
	Change the USB cable
The device is not detected by the DeviceTool or Ethernet software.	Unplug to restart the device.
	Change the Ethernet cable
	Check the selection of Ethernet networks before opening.
The device is not detected on the network.	Check the mode of communication with LED signals and reconfigure the device via USB if necessary
	Verify that the IP addresses and subnet mask are configured correctly.
	Update the firmware of the device via the software or DeviceTool
	Update the software with the latest version and try again
	Open and allow the Communication Ports used by the device. Some local networks may require manual opening of the following UDP Ports: 8011 + 8012 for communication between the device and software.

If you experience unlisted issues, contact your seller or manufacturer directly to indicate your problem and receive a solution.

Product design and specifications are subject to change without prior notice.

Older devices (sold before 2020) are not compatible with PRO DMX version 2



191 Allée de Lauzard
34980 St Gély du Fesc, FRANCE
Web: www.chromateq.com
Email: info@chromateq.com
Phone: +33 952210755

Wechat: Chromateq
WhatsApp: +8613422062209
QQ: 2908265661



Guaranteed products: 1-3-5 years
Software pack: <https://chromateq.com/dmx-software-downloads/>

Copyright © 2021 - CHROMATEQ. All rights reserved.