



AL-WS-DMX v2 wall dimmer with DMX output and 3-way support



Product Description - AL-WS-DMX

This switch operates just like any standard residential light switch – however it uses DMX512 for communication with other devices. This DMX source in a standard residential style outline fits into any home, looks like any switch yet requires no licensed electrician for installation – the dimmer itself uses under 50 mw yet controls thousands of watts of lighting. Stand alone it operates as a single Universe for one DMX address. It has DMX in and DMX out for daisy chaining multiple switches. The DMX address and light mode is set by a dip switch.

The On/Off switch is like any normal switch. The slider sets the brightness. In Color modes, the slider can adjust the RGB color as well.

Each switch operates in collision detection, multi master mode – each one builds a universe of DMX addresses and learns the status of other switches. Thus multiple switches can control the complete universe. In single address mode 7 operation, the device supports 3-way switching – each switch can share the same destination DMX512 address and the last switch moved will control the On/Off and dim level.

To save space – the connector used is a RJ-11 phone type connector with power and data on the same connector. Supply the switch with 12v to 56v and connect the data pins to your DMX device with a RJ11 to XLR jumper cable as shown below. Use simple phone wire up to 1000 ft over standard CAT-3 2 pair telephone wire. Termination of the end of the line is essential, and a termination switch is provided.

In modes other than 7 – this device is designed to be used in a one switch, one DMX address configuration without 3-Way, you can still share the bus between different addresses.

Fully scalable to a 512 light DMX universe, this building block in a 100% low voltage led lighting solution allows low cost installations of wall switches controlling DMX lights;

Specifications

Power and data source and passthru	RJ 11 female connectors (2)
Power Protocol	Passive power from the RJ11
Input voltage range	12v to 57 volts
Power pins in	See Diagram
Data pins (DMX512 over Rj11)	XLR2 D+ and XLR3 D- with collision detection
Max Power consumption	50 milliwatts
Addressing	512 unit addresses via dip switch
Protection	Reverse protection and static protection
Operating Temperature	0°C ~ 50°C
Size	108H (metal) 70H x 34 D x 42 W mm
Multi Master shared DMX bus	Supported
3-Way operation with multiple switch	Supported in single address, white only
Termination Resistor	Version 3 hardware adds a switch for simple 120 ohm termination at the end of the run

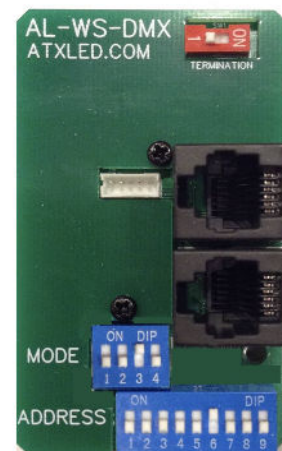

	RJ12	RJ11	XLR3	XLR5	Function
	1 nc				
	2 +48	1 +48			
	3 D+	2 D+	2	3	D+
	4 D -	3 D -	3	2	D -
	5 Gnd	4 Gnd	1	1	Gnd
6 nc					

DMX wall switch configuration

The AL-DMX wall switch is designed for these operational modes:

- Control of single address, white light DMX drivers with a 512 single addresses
- 3-Way switching options – up to 16 addresses with up to 8 switches each
- Control of DMX512 RGB drivers with three popular RGB channel assignments. Addresses from 1 thru 500 are supported. Multiple switches can share the same DMX bus and control different destination addresses. Contact us for specialty RGB addressing methods.

At power up, and every 5 seconds – the PB5 LED will flash to display the operational status – it will flash 1 long pulse for mode 0 (default) or 1 thru 15 pulses for the modes as shown below. This is best viewed if the switch is turned off.

At power up – the color and On/Off/Dim levels will be restored to those values before the power outage

DMX 3-Way control

Multiple DMX switches on the same bus operate in 3-Way mode for up to 16 DMX fixture addresses 1-16. We use DMX addresses 17 thru 512 to construct a representation of up to 256 physical switches. Set each switch to an address from 1 to 16.

One or many switches can have the same DMX address (from 1 to 16). The state information required to resolve the On/Off/Dim status of the combination of all 256 possible combinations is stored in the DMX universe and correctly interpreted by the switches.

NOTE: 120 ohm termination of both ends of the DMX bus is critical and essential.

DMX color / brightness control

Turn the switch on to adjust the brightness with the slider.

Turn the switch off to adjust the color. Movement of the slider with the switch OFF will turn the output ON, the slider will cause the color to change, (the output will stay on for 2 seconds). To end the color change option, wait 2 seconds or turn the switch on. The color will be stored inside the switch and will be restored at the next power cycle.



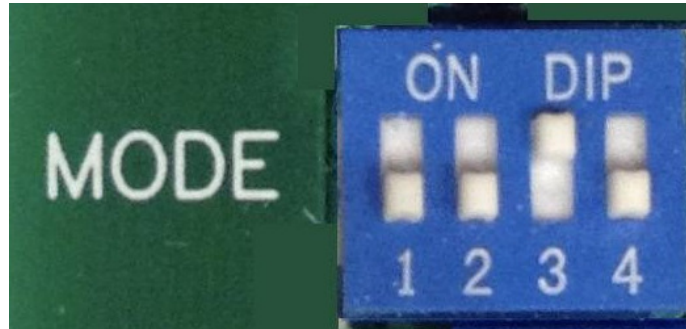

Setting the Slider to the top will set White. From bottom to top will select RGB color mixtures

DMX Addressing modes

The Rocker switch and the 4 dip switches control the feature code – see the table below. A function code of 0 (with rocker on) resets all values to factory default (ATX non DMX mode). Please use modes 1 thru 15 for DMX. When changing the switch settings on a powered device – the changes will not be applied until the switch is turned on or off at least once.

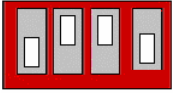
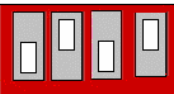
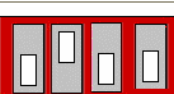

DIP Switch	value	Feature Codes – configuration settings	Default Refresh Rate	Address block size
	15	RGB mode type '1234' Red is Channel 1, Green is Channel 2, Blue is Channel 3. The slider selects the Color if off, brightness if on, if RGB==255, then only channel 4 (white) will be controlled	NC	4
	14	Consecutive mode 12 DMX address 1 thru 12 will be given the same value from the ON/OFF switch and dimmer	NC	12
	13	Tunable White mode. DMX Address odd is Warm White, next sequential even address is Cool White.	NC	NC
	12	Consecutive mode 8 DMX address 1 thru 8 will be given the same value from the ON/OFF switch and dimmer	NC	8
	11	RGB Mode type '567' Channel 1 = is brightness, Red is Channel 5, Green is Channel 6, Blue is Channel 7. Slider sets brightness if switch is up and color if down.	5 Hz	8
	10	Consecutive mode 4 DMX address 1 thru 4 will be given the same value from the ON/OFF switch and dimmer slider	NC	4
	9	Consecutive mode 2 DMX address 1 and 2 will be given the same value from the ON/OFF switch and dimmer slider	NC	2
	8	RGB mode type '123' Red is Channel 1, Green is Channel 2, Blue is Channel 3. The slider selects the Color if off, brightness if on	NC	4
	7	3-Way mode. Support for up to 15 switches in virtual 3-Way. Same as mode 1, plus 3-way. Use addresses 1-15, slider controls brightness.	NC	NC

	6	Consecutive mode 16 DMX address 1 thru 16 will be given the same value from the ON/OFF switch and slider dimmer	NC	16
	5	Set DMX Refresh rate. Turn switch off, set value=5, turn switch on, Slider changes refresh rate from 40 hz (top) or slower – LED flashes to show the rate. DMX packets are sent during this setup. When done, turn the rocker off and the speed will be stored.	set	NC
	4	White spotlight mode. Channel 1 = 255 for ON, 0 for OFF, Channel 5 is dimmable from 0 – 255 by the slider..	5 Hz	8
	3	RGBW mode. Set DMX Color using the slider to Color or White If white, then Channel 1 is brightness from 9-134, Channel 5 is 255. if color, then Channel 1 is 255 and Channel 2,3,4 are the colors RGB. Color and intensity are controlled by the slider	5 Hz	8
	2	RGB mode type '234' Channel 1 = brightness, Red is Channel 2, Green is Channel 3, Blue is Channel 4. Channel 1 is the DMX address (from 8 to 496), The slider selects the Color if off, brightness if on	5 Hz	4
	1	Simple single channel mode. The brightness goes from 0-255 at the DMX address	5 Hz	1
	0	reset to Factory Default, resets all functions ATX-LED non-DMX Mode is default – see last page	60s	8

NC = No Change

DMX Start Address



Example:

Address 1 is switch #1 on and the rest off

Address 4 is switch #3 on and the rest off

Address 10 is switch #2 and #4 on and the rest off

Address 20 is switch #3 and #5 on and the rest off

XLR to RJ11 Adapter PCB

This optional device adds power to the RJ11 connector and has an XLR connector for standard fixtures. A standard 2.1mm x 5.5mm DC connector is used for power.

Input power is 12v to 48v, it has a fuse for protection, plus static protection Diodes and an optional termination resistor (120 ohms) - set the Jumper to implement termination.

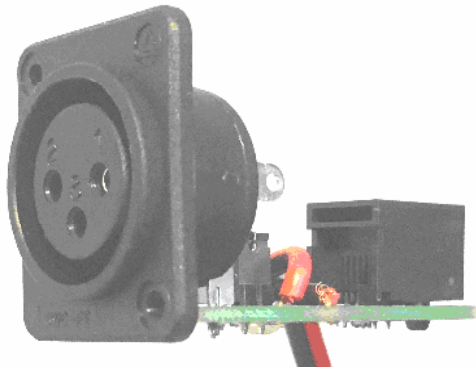

XLR connector

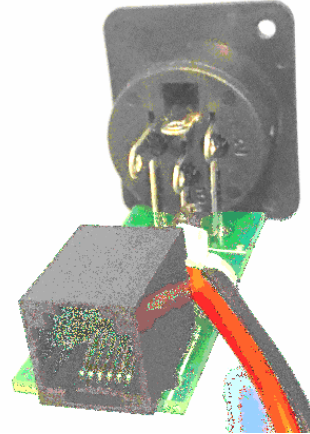

RJ11 connector

DALI – DMX hybrid example

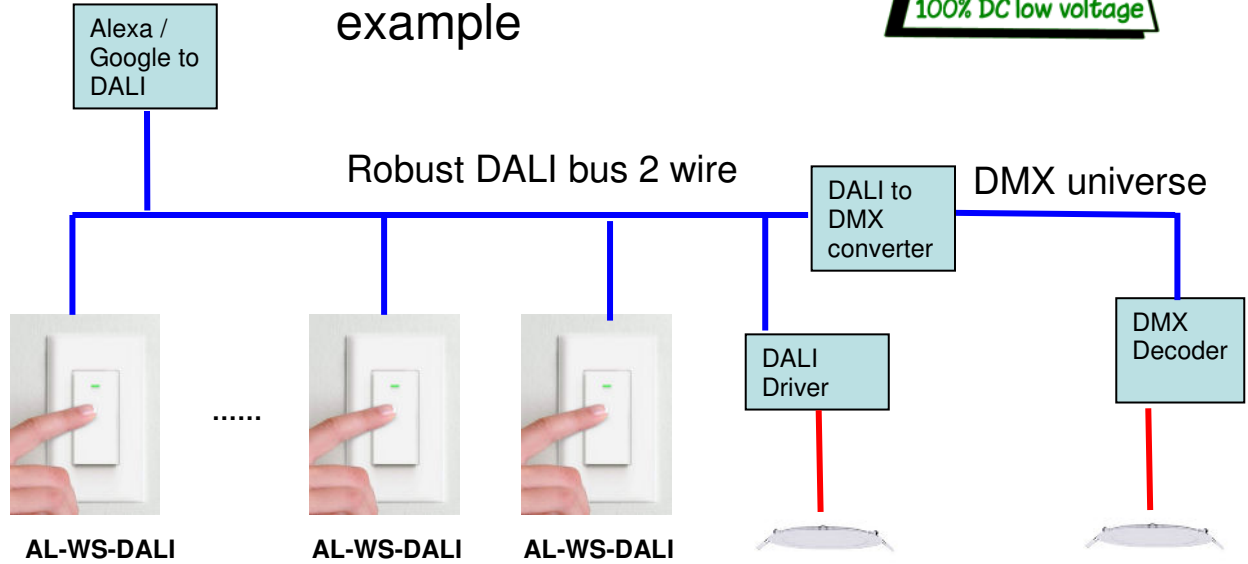

Other DALI Devices from ATX LED



AL-WS-PWM2

DALI bus and 56 watts



AL-WS-DALI

DALI bus and 0-10v



AL-WS-Bath

Dual output for LED and Bath fans



AL-WS-DR1

Low cost 24 watt driver



AL-WS-DR2

Switch for 3-way Momentary

App interface for cloud control

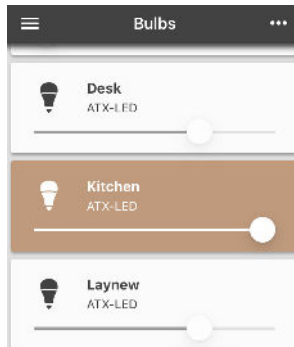

Special ATX LED Residential mode

DMX Packet: Special DMX packet header from the switch, must be used with a PL-DR1 device

DMX address	1	2	3	4	5	6	7	DMX	DMX+1
Content	100	DMX bit 8	DMX 0-7	Random H	Random L			0 if off else DIM	DIM Level

Stand Alone operation:

- In default mode in a small system – simply set the 4 address switches to the address of the ATX-LED LED driver, nothing else needs to be done.
- 4 bits of DIP switch addresses, addresses possible are 8, 16, 24, 32, etc up to 120. This is the DMX Base Address (N)
- Higher addresses are possible with the config options shown on page 4
- DMX512 repeat interval is 1 minute - switch repeats each 60 seconds by default – for higher speeds see page 4
- For 3-Way operation a 16 bit random number is coded into fields 4 and 5
- Slider is brightness. Slider works in On or Off state.
- DMX512 address is set to brightness if Switch is ON (simple mode) or 0 if off
- DMX512 address +1 is set to the brightness only – for 3-Way resolution.
- Daisy chain up to 8 switches in series using the RJ11 connector – connect one end to a AL-DR driver, if the distance between switches is over 2 feet – terminate the last switch furthest from the LED driver with a 120 ohm resistor.

Consolidated operation:

When combined with a AL-DR1 consolidator - This mode supports:

- N-Way light control – multiple switches on the same DMX address will be XOR'd to control the light on/off and dimming. Last switch moved sets the dim level and On/Off
- Loop prevention. Since we consolidate up to 64 switches in one DMX universe, we create a loop to communicate between up to 8 controllers.
- Any of our AL-DMX-DR devices can consolidate up to 64 switches, resolve 3-way, and output a complete DMX universe.
- Output packet is standard DMX512 – do not assign any fixture to address 1 thru 8

Note: Address 508 is the hardware version, and 509 is the software version – use a DMXking monitor to observe.



Austin Led Consultants

DMX and Led power over ethernet

ATX LED Consultants Inc
815-A Brazos #326
Austin Tx, 78701
512 377 6052
<http://atx-led.com>