

Ultra-Pro 5CH RDM DMX512 Decoder

70060025



Important: Read All Instructions Prior to Installation

Function introduction

3/5 Pin male & female XLR terminal: DMX512 signal input & output
 2xRJ45 terminal: DMX512 signal input & output

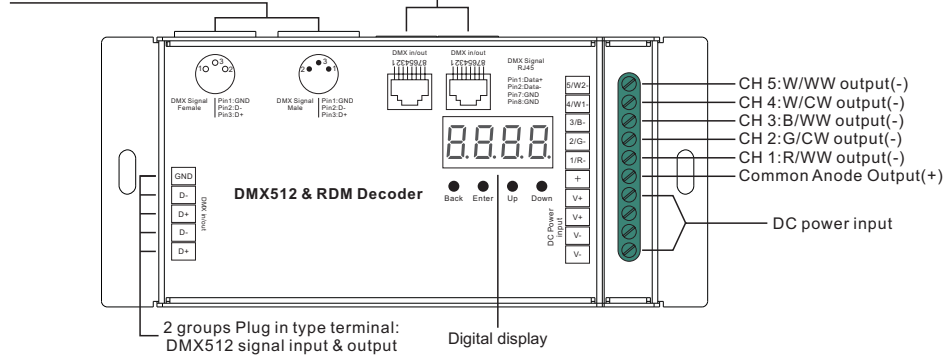

Product Data

Input Voltage	Output Current	Output Power	Remarks	Size(LxWxH)	Protection
12-24VDC	5x8A	5x(96-192)W	Constant voltage	164x73x38mm	Short circuit
12-48VDC	5x350mA	5x(4.2-16.8)W	Constant current	164x73x38mm	Short circuit
12-48VDC	5x700mA	5x(8.4-33.6)W	Constant current	164x73x38mm	Short circuit

- Master & decoder mode, RDM function
- Metal housing, digital display to show data directly, easily to set and show DMX address.
- With multiple kinds of DMX in/out ports: RJ 45, XLR , normal screws.
- Total 5 PWM output channels, common anode. DMX channel quantity from 1CH-5CH settable
- PWM output resolution ratio 8bit , 16bit settable.
- Output PWM frequency from 500HZ ~ 35K HZ settable.
- Output dimming curve gamma value from 0.1 ~ 9.9 settable.
- Decoding mode settable.
- Galvanic isolation

Safety & Warnings

- DO NOT install with power applied to device.
- DO NOT expose the device to moisture.

Operation

Before you do other settings, please set the device to be Master or Decoder mode.

run1 = DMX Decoder mode, **run2** = DMX Master mode(stand alone).

Keep on clicking Down button, to get run1 or run2, then click Enter, then click Down button to choose 1 or 2, then click Back button.



I. For run2 DMX Master mode: Keep on clicking Up button, you will find following menus on display:

8.8.8.8 Means brightness for each output PWM channel. First 1 means PWM output channel 1 and it is selectable from 1 to 5 by clicking "UP" or "Down" button. Second 01 means brightness level, click "Enter" button, the display flashes, then click "UP" or "Down" button to select from 00-99-FL, which means 0%-99%-100% brightness, then click "Back" button to confirm.

P.XXX Means programs , total 1~31 programs.

8-XX Means RGB running effect's brightness, total 1~8 levels brightness

SP-X Means effect play speed. total 1~9 levels speed.

P-XX means RGB color changing modes, total 31 programs:

- 00- RGB off
- 01- Static red
- 02- Static green
- 03- Static blue
- 04- Static yellow (50% red+50% green)
- 05- Static orange (75% red+25% green)
- 06- Static cyan (50% green+50% blue)
- 07- Static purple (50% blue+50% red)
- 08- Static white (100% red+100% green+100% blue)
- 09- Any two colors of RGB mix fade, changing diagram as follow:

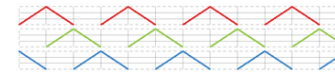

11- RGB FADE OUT & FADE IN, changing diagram as follow:



13- RGB FADE IN, changing diagram as follow:



15- RGB 3 colors strobe

16- White color strobe (100% red+100% green+100% blue)

17- 7 colors FADE OUT & FADE IN (red, orange, yellow, green, cyan, blue, purple FADE OUT & FADE IN)

18- 7 colors jump changing (red, orange, yellow, green, cyan, blue, purple jump changing)

19- 7 colors strobe (red, orange, yellow, green, cyan, blue, purple strobe)

20- Red-white (100% red+100% green+100% blue) circle gradual changing

21- Green-white (100% red+100% green+100% blue) circle gradual changing

22- Blue-white (100% red+100% green+100% blue) circle gradual changing

23- Red-orange circle gradual changing

24- Red-purple circle gradual changing

25- Green-yellow circle gradual changing

26- Green-cyan circle gradual changing

27- Blue-purple circle gradual changing

28- Blue-cyan circle gradual changing

29- Red-yellow-green circle gradual changing

30- Red-purple-blue circle gradual changing

31- Green-cyan-blue circle gradual changing

II. For run1 DMX decoder mode: Keep on clicking Up button, you will find following menus on display:

DMX signal indicator **●**: When DMX signal input is detected, the indicator on the display following after **8** turns on red **8.XXX** .

8.XXX Means DMX address. factory defaults setting is 001.

88XX Means DMX channels quantity. factory defaults setting is Ch05

88XX Means Bit (8bit or 16bit). factory defaults setting is 16bit

88XX Means output PWM frequency. factory defaults setting is 1K HZ

88XX Means output dimming curve gamma value, factory defaults setting is ga 1.5

88XX Means Decoding mode, factory defaults setting is dp1.1

10- RGB colors mix fade, changing diagram as follow:

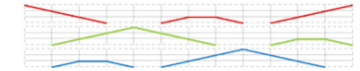

12- RGB jump changing, changing diagram as follow:



14- RGB FADE OUT, changing diagram as follow:

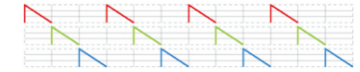

By holding button Back + Enter together at the same time over 5 seconds until the display goes off, it will restore to default settings .

Wiring diagram

1.Work as Master mode

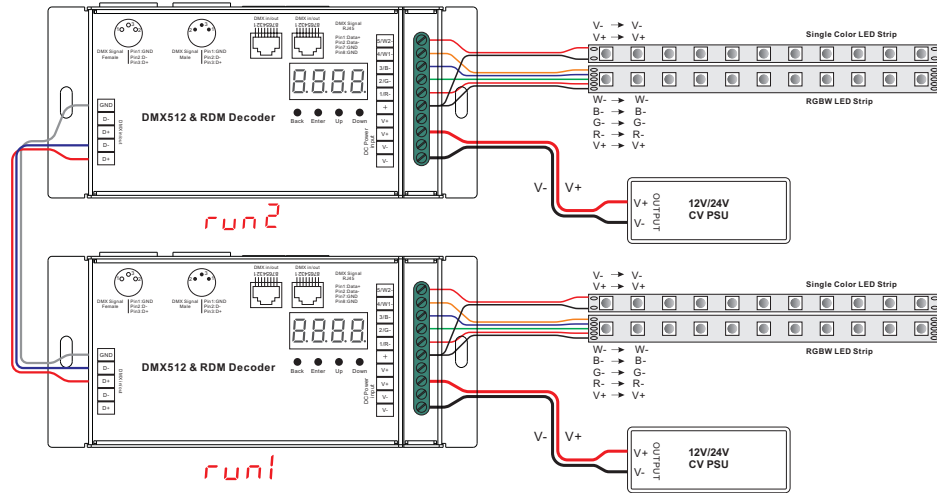

2.Work as Decoder mode

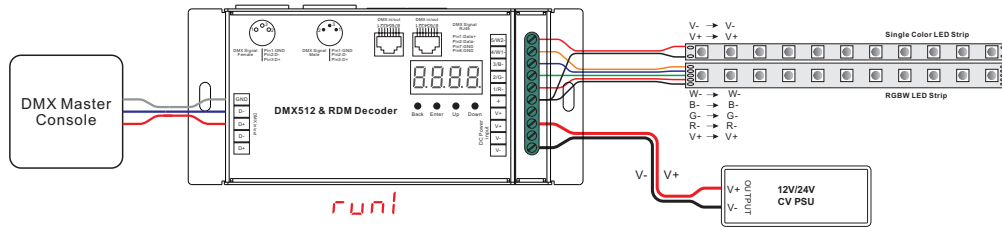

1. DMX address setting:

select menu **8 XXX** , click button "Enter", display flashes, then click or hold button "Up" / "Down" to set DMX address (click is slow, hold is fast.), then click button "Back" to confirm.

2. DMX channel quantity setting:

Select menu **88 XX**, click button "Enter", display flashes, then click button "Up" / "Down" to set DMX channel quantity , then click button "Back" to confirm.

For example the DMX address is already set 001.

CH01=1 DMX address for all the output channels, which are all address 001.

CH02=2 DMX addresses , output 1&3 is address 001, output 2,4&5 is address 002

CH03=3 DMX addresses, output 1, 2 is address 001,002, output 3,4&5 is address 003

CH04=4 DMX addresses, output 1,2,3 is address 001,002,003, output 4&5 is address 004

CH05=5 DMX addresses, output 1,2,3,4,5 is address 001,002,003,004,005.

3. PWM output resolution Bit setting:

select menu **88 XX** , click button "Enter", display flashes, then click button "Up" / "Down" to choose 08 or 16 bit, then click button "Back" to confirm.

4. output PWM frequency setting:

select menu **88 XX** , click button "Enter", display flashes, then click button "Up" / "Down" to choose 00~35, then click button "Back" to confirm. 00=500HZ, 01=1kHz, 02=2kHz.....25=25kHz, 35=35kHz.

5. output dimming curve gamma value setting:

select menu **88 XX** , click button "Enter", display flashes, then click or hold button "Up" / "Down" to choose 0.1~9.9, then click button "Back" to confirm.

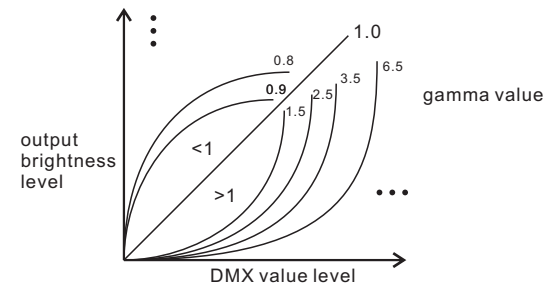

6. DMX decoding mode setting:

Select menu **88 XX** , click button "Enter", display flashes, then click or hold button "Up" / "Down" to choose the decoding mode, then click button "Back" to confirm. "dPxx" means the DMX address quantity used for control of corresponding PWM output channel quantity. 1st "x" is DMX address quantity, 2nd "x" is PWM channel quantity.

Fine dimming: the fine dimming effect can only be visible when the dimming curve gamma value is set lower than 1.4, and the lower the value is, the more visible the fine dimming effect will be.

DMX address is 001, CH01

DMX Console Slider number	dp1.1	dp2.1
DMX channel		
1	for all output dimming	for all output dimming
2	No use	for all output fine dimming

DMX address is 001, CH02

DMX Console Slider number	dp1.1	dp2.1	dp3.2
DMX channel			
1	for output 1&3 dimming	for output 1&3 dimming	for output 1&3 dimming
2	for output 2,4 &5 dimming	for output 1&3 fine dimming	for output 2,4 &5 dimming
3		for output 2,4 &5 dimming	for all output dimming
4		for output 2,4&5 fine dimming	

DMX address is 001, CH03

DMX Console Slider number	dp1.1	dp2.1	dp4.3	dp5.3
DMX channel				
1	for output 1 dimming	for output 1 dimming	for output 1 dimming	for output 1 dimming
2	for output 2 dimming	for output 1 fine dimming	for output 2 dimming	for output 2 dimming
3	for output 3,4 &5 dimming	for output 2 dimming	for output 3,4&5 dimming	for output 3,4&5 dimming
4		for output 2 fine dimming	for all output master dimming	for all output master dimming
5		for output 3,4 &5 dimming		strobe effects
6		for output 3,4&5 fine dimming		

DMX address is 001, CH04

DMX Console Slider number	dp1.1	dp2.1	dp5.4	dp6.4
DMX channel				
1	for output 1 dimming	for output 1 dimming	for output 1 dimming	for output 1 dimming
2	for output 2 dimming	for output 1 fine dimming	for output 2 dimming	for output 2 dimming
3	for output 3 dimming	for output 2 dimming	for output 3 dimming	for output 3 dimming
4	for output 4&5 dimming	for output 2 fine dimming	for output 4&5 dimming	for output 4&5 dimming

5		for output 3 dimming	for all output master dimming	for all output master dimming
6		for output 3 fine dimming		strobe effects
7		for output 4 &5 dimming		
8		for output 4&5 fine dimming		

DMX address is 001, CH05

DMX Console Slider number	dp1.1	dp2.1	dp6.5	dp7.5
DMX channel				
1	for output 1 dimming	for output 1 dimming	for output 1 dimming	for output 1 dimming
2	for output 2 dimming	for output 1 fine dimming	for output 2 dimming	for output 2 dimming
3	for output 3 dimming	for output 2 dimming	for output 3 dimming	for output 3 dimming
4	for output 4 dimming	for output 2 fine dimming	for output 4 dimming	for output 4 dimming
5	for output 5 dimming	for output 3 dimming	for output 5 dimming	for output 5 dimming
6		for output 3 fine dimming	for all output master dimming	for all output master dimming
7		for output 4 dimming		strobe effects
8		for output 4 fine dimming		
9		for output 5 dimming		
10		for output 5 fine dimming		

The data definitions for strobe channel are as follows:

```
{0, 7},//undefined
{8, 65},//slow strobe-->fast strobe
{66, 71},//undefined
{72, 127},//slow push fast close
{128, 133},//undefined
{134, 189},//slow close fast push
{190, 195},//undefined
{196, 250},//random strobe
{251, 255},//undefined
```

The supported RDM PIDs are as follows:

```
DISC_UNIQUE_BRANCH
DISC_MUTE
DISC_UN_MUTE
DEVICE_INFO
DMX_START_ADDRESS
IDENTIFY_DEVICE
SOFTWARE_VERSION_LABEL
DMX_PERSONALITY
DMX_PERSONALITY_DESCRIPTION
SLOT_INFO
SLOT_DESCRIPTION
MANUFACTURER_LABEL
SUPPORTED_PARAMETERS
```

RDM Discovery Indication:

When using RDM to discover the device, the digital display will flash and the connected lights will also flash at the same frequency to indicate. Once the display stops flashing, the connected light also stops flashing.

Restore to Factory Default Setting

Press and hold down both "Back" and "Enter" keys until the digital display turns off, then release the keys, system will reset and the digital display will turn on again, all settings will be restored to factory default.

Default settings are as follows:

DMX Address Code: a001

DMX Address Quantity: SW1=0: ch05, SW1=1: ch04

PWM Resolution Mode: bt16

PWM Frequency: pf01

Gamma: ga1.5

Decoding Mode: dp1.1

Product Dimension

